



Vent Free Log Sets

INSTALLATION & USER'S MANUAL

Burner Models: VFBUL**M(N/P)(-SS), VFBUL**V(N/P)(-SS), VFBUL**E(N/P)(-SS)
Log Models: VFWO**, VFRO**, VFSSO**, VFAB**
** SIZES: 18, 24, or 30



WARNING

THIS APPLIANCE IS EQUIPPED FOR EITHER NATURAL GAS OR PROPANE GAS. FIELD CONVERSION IS NOT PERMITTED



Report # F19-108

ANS Z21.11.2-2019,
ANS Z21.60-2017 –
CSA 2.26-2017



WARNING: If the information in this manual is not followed exactly, a fire or explosion may result, causing property damage, personal injury, or loss of life.

– Do not store or use gasoline or other flammable vapors and liquids in the vicinity of this or any other appliance.

– WHAT TO DO IF YOU SMELL GAS

- Do not try to light any appliance
- Do not touch any electrical switch; do not use any phone in your building.
- Immediately call your gas supplier from a neighbor's phone. Follow the gas supplier's instructions.
- If you cannot reach your gas supplier, call the fire department.

– Installation and service must be performed by a qualified installer, service agency or gas supplier.

This is an UNVENTED gas-fired heater. It uses air (oxygen) from the room in which it is installed. Provisions for adequate combustion and ventilation air **MUST** be provided. Refer to "SAFETY INFORMATION" in Section 2.0 of this manual.

INSTALLER: Leave this manual with the appliance.
CONSUMER: Retain this manual for future reference.



Contents

- 1.0 Introduction 2
 - 1.1 General..... 2
 - 1.2 Technology & Specifications 2
 - 1.2.1 Specifications 2
 - 1.2.1.1 Gas Types 2
 - 1.2.1.2 Ignition Type..... 2
 - 1.2.1.3 Pilot Type 2
 - 1.2.1.4 Controllable Features 2
 - 1.2.1.5 Sizing and Gas Pressures 2
- 2.0 Safety Information 4
- 3.0 Usage Instructions..... 6
 - 3.1 Pre-Usage Information..... 6
 - 3.1.1 Guidelines 6
 - 3.2 Operating This Appliance Safely 7
 - 3.3 Lighting Instructions..... 7
 - 3.3.1 Lighting Instructions, Millivolt 8
 - 3.3.2 Lighting Inst., Variable Control 9
 - 3.3.2.1 Manual Mode..... 10
 - 3.3.2.2 Thermostat Mode 11
 - 3.3.3 Lighting Instr., Variable Electronic..... 11
 - 3.4 Cleaning and Servicing 13
 - 3.4.1 Monthly Cleaning 13
- 4.0 Pre-Installation Instructions 14
 - 4.1 General..... 14
 - 4.2 Pre-Installation Precautions & Safety..... 14
 - 4.3 Burner System Requirements..... 15
 - 4.4 Vented Installation Restrictions..... 15
 - 4.5 Unvented Installation Restrictions 15
 - 4.5.1 Determining a Confined Space 16
 - 4.5.2 Installing in a Confined Space 16
 - 4.6 Clearances to Combustibles 17
 - 4.6.1 Clearance IN FRONT 17

- 4.6.2 Clearance ABOVE 17
- 4.7 Fitting the Unit..... 18
 - 4.7.1 Location 18
 - 4.7.2 Mounting Clearances 18
 - 4.7.3 Optional Chimney Venting..... 18
 - 4.7.4 Product Installation Illustration 18
 - 4.7.5 Product Dimensions 18
- 4.8 Preparation 20
 - 4.8.1 Unpacking..... 20
 - 4.8.2 Gas Connections 21
- 5.0 Installation 21
 - 5.1 Installation Safety Information 21
 - 5.1.1 Fireplace Floor Requirements 22
 - 5.1.2 Installing the Burner Unit..... 22
 - 5.1.3 Installing the Remote Control 23
 - 5.1.3.1 Installing the Millivolt Remote 23
 - 5.1.3.2 Installing the Variable Remote .. 24
 - 5.1.3.3 Installing the Var. Elect. Remote 25
 - 5.1.4 Setting the Controls..... 26
 - 5.1.5 Checking the Gas Pressure 26
 - 5.1.6 Placing Decorative Media..... 27
 - 5.1.6.1 Placing Glowing Embers 27
 - 5.1.6.2 Placing Lava Rock 27
 - 5.1.6.3 Making the Media Consistent 27
 - 5.1.7 Log Set Placement..... 27
 - 5.1.7.1 18 Log Set Placement – WO/RO..... 28
 - 5.1.7.2 24 Log Set Placement – WO/RO..... 28
 - 5.1.7.3 30 Log Set Placement – WO/RO..... 29
 - 5.1.7.4 Checking the Log Placement 30
 - 5.2 Vent Free Logs Parts List..... 31
 - 5.3 Vent Free Burner System Replacement Parts List..... 37



5.4 Warranty.....41

Important: For safe operation and proper performance of this product and to comply with certification, listings, and building code acceptances, use ONLY Grand Canyon Gas Logs controls, parts & accessories that have been specifically listed or certified for use with this burner system. Use of other controls, parts, or accessories is prohibited and will void all warranties, certifications, listings and building code approvals, and may cause property damage, personal injury, and loss of life.

1.0 Introduction

This document provides user and installation information for the Grand Canyon Logs Vent Free Log Sets. It is intended to be installed as an unvented supplemental heating appliance in a new or existing site.

1.1 General

It is important that you read and follow these instructions carefully if intending to use or install this appliance. Pay close attention to all safety and operational instructions contained in this document.

1.2 Technology & Specifications

- Lifelike coals and flaming logs are created by applying a flame source to the appropriate media.
- Because it uses gas (LP or Natural), the fire also provides heat that is radiated from the hot media elements within an enclosure.
- The output is at such a level that a vent is not required (as long as safety conditions are met).

1.2.1 Specifications

1.2.1.1 Gas Types

- Natural
- LP (Propane)

1.2.1.2 Ignition Type

- Manual Hand-Held Flame Source can be used on all models as backup for Piezo lighter
- Manual Piezo (Continuous Pilot Light) used on the “*Millivolt*” & “*Variable Control*” models
- Automatic Piezo (Non-Continuous Pilot Light) used on the “*Variable Electronic*” models

1.2.1.3 Pilot Type

ODS (Oxygen Depletion Sensing)

1.2.1.4 Controllable Features

- Wireless remote control
- Flame On/Off, manual
- Flame On/Off, remote thermostatic setting

- Flame height and intensity, manual setting
- Flexible Media Placement

1.2.1.5 Sizing and Gas Pressures

Refer to Tables 1 and 2 below for sizing information and gas pressures/BTU ratings for the various models. Note that the gas pressure requirements do not change for the 3 types of valve and control options that are offered.

MINIMUM SIZE REQUIREMENTS								
Burner Model	Minimum Fireplace Size				BTU Ratings			
	Width		Depth	Height	Natural Gas		Propane Gas	
	Front	Rear			Low Setting	High Setting	Low Setting	High Setting
VFVUL18 (18" Log Set)	22"	20"	13"	18"	26k	35k	24k	32k
VFVUL24/30 (24" Log Set)	28"	20"	14"	18"	19k	37k	19k	37k
VFVUL24/30 (30" Log Set)	34"	20"	14"	18"	19k	37k	19k	37k

TABLE 1

GAS PRESSURE SPECIFICATIONS			
NATURAL GAS		PROPANE GAS	
Outlet pressure reading: (Flame adjustment on high)	Typical 3.5" w.c	Outlet pressure reading: (Flame adjustment on high)	Typical 10.0" w.c
Inlet pressure reading	Max. 10.5" w.c Min. 5" w.c	Inlet pressure reading	Max 13" w.c Min. 11" w.c

TABLE 2

2.0 Safety Information

UNVENTED ROOM HEATER GENERAL SAFETY INFORMATION:

1. Due to high temperatures, this appliance should be located out of traffic and away from furniture/draperies.
2. Children and adults should be alerted to the hazard of high surface temperatures and should stay away to avoid burns or clothing ignition.
3. Young children should be carefully supervised when in the same room with this appliance.
4. Do not place clothing or any flammable material on or near your vent-free gas appliance. Matches, paper, garbage or any other material must not be thrown on top of the logs, burner or into the flame.
5. Any safety screen, guard, or barrier removed for servicing this appliance must be replaced prior to operating the heater.
6. Installation and repair should be done by a qualified service person. The appliance should be inspected before use and at least annually by a professional service person. More frequent cleaning may be required due to excessive lint from carpeting, bedding material etc. It is imperative that control compartments, burners, and circulating air passageways of the appliance be kept clean.

7.

 **WARNING: FIRE, EXPLOSION, AND ASPHYXIATION HAZARD**

Improper adjustment, alteration, service, maintenance, or installation of this heater or its controls can cause death or serious injury.

Read and follow Instructions and precautions in this User's Information Manual provided with this heater

8.

This appliance is intended for supplemental heating.

9. Do not block air intakes any manner and maintain adequate clearances to enable the free flow of air.
10. This heater shall not be installed in a room or space unless the required volume of indoor combustion air is provided by the method described in the *National Fuel Gas Code*, ANSI Z223.1/NFPA 54, the *International Fuel Gas Code*, or applicable local codes.
11. Provide adequate clearances for servicing and operation.
12. Do not install this appliance directly on combustible flooring. Be certain that the top surface of the combustible flooring material (i.e. carpet, tile, etc.) is not too close to this gas appliance. If this appliance is at floor level or less than 6" above the top surface of the flooring material, there must be at least 12" of noncombustible material between the base of the fireplace and any surface of the combustible flooring.

13. At least 10"-12" of noncombustible or heat-resistant material is required above the fireplace. A fireplace hood will be required to act as a heat deflector in protecting combustible fireplace surrounds (facing and/or mantel) if certain minimum clearances cannot be met (see the "Clearances to Combustibles" section).
14. A vent-free room heater having an input exceeding 10,000 BTU per hour (2,931 Watts) shall not be installed in a bedroom or bathroom (ANSI Z21.11.2). This includes ALL models in this manual.
15. A vent-free room heater having an input exceeding 6,000 BTU per hour (1,758 Watts) shall not be installed in a bathroom (ANSI Z21.11.2). This includes ALL models in this manual.
16. **WARNING:** Failure to keep the primary air opening(s) of the burner(s) clean may result in sooting and property damage.
17. **WHEN INSTALLING AS A DECORATIVE VENTED APPLIANCE, THE UNIT MUST CONFORM TO ALL LOCAL CODES OR, IN THE ABSENCE OF LOCAL CODES, TO THE NATIONAL FUEL GAS CODE ANSI Z223.1/NFPA 54.**
18. The appliance and its appliance main gas valve must be disconnected from the gas supply piping system during any pressure testing of that system at test pressure in excess of ½ psi (3.5 kPa). The appliance must be isolated from the gas supply piping system by closing its equipment shutoff valve during any pressure testing of the gas supply piping system at test pressure equal to or less than ½ psi (3.5 kPa).
19. Keep the area around your gas appliance clear of combustible materials, gasoline, and any other flammable vapors/liquids. Be especially cautious if the gas appliance is installed in a basement or converted garage.
20. Do not use this appliance if any part has been underwater. Immediately call a qualified professional service technician to inspect the appliance and to replace a part of the control system and any gas control which has been under water.
21. Perform a periodic visual check of the pilot and burner flame. It should appear as shown in Figure 1.
22. **WARNING:** This appliance is for installation only in a solid-fuel burning masonry or UL 127 factory-built fireplace or in a listed vent free firebox enclosure. It has been design certified for these installations.
Exception: DO NOT Install this appliance in a factory-built fireplace that includes instructions stating it has not been tested or should not be used with unvented gas logs.
23. **WARNING:** Before installing in a solid-fuel burning fireplace, the chimney flue, danger and firebox must be thoroughly **CLEANED** of soot, creosote, ash, and loose paint by a qualified chimney cleaner.
24. **WARNING: DO NOT ALLOW FANS TO BLOW DIRECTLY INTO THE FIREPLACE. AVOID ANY DRAFTS THAT ALTER FLAME PATTERNS.**
25. **WARNING: DO NOT USE A BLOWER INSERT, HEATER EXCHANGER INSERT, OR OTHER ACCESSORY NOT APPROVED FOR USE WITH THIS HEATER.**
26. For unvented gas logs for installation in bedrooms or bathrooms, the burner base assembly must be secured to the fireplace or the firebox floor in accordance with these installation instructions when the unvented gas log is installed in a bedroom or bathroom, as applicable.
27. A fireplace screen must be in place when this appliance is operating, unless other provisions for combustion air are provided, the screen has an opening(s) for introduction of combustion air.

28. It is important to use the gas logs in a that the minimum size fireplace as indicated in the “Product Drawing” section showing the height and width of the front opening and depth.
29. **SOLID-FUEL MUST NOT BE BURNED** in the fireplace where this unvented gas appliance is installed.
30. **GLASS DOORS MUST BE FULLY OPEN** when this vent-free gas appliance is operating. This appliance **MUST NOT BE ON** if glass doors are closed, as it can lead to sooting, burner outages and possibly explosion, causing damage or injury.
31. Any outside air ducts and/or ash dumps located on the floor or walls of the fireplace must be permanently sealed shut before the installation. Use heat-resistant sealant. Do not seal chimney flue damper.
32. **STATE AND LOCAL CODES MAY ONLY ALLOW OPERATION OF THIS APPLIANCE IN A VENTED CONFIGURATION. CHECK YOUR STATE OR LOCAL CODES.**
33. **WARNING: CARBON MONOXIDE POISONING MAY LEAD TO DEATH.**

Early signs of carbon monoxide poisoning are similar to the flu, with headaches, dizziness, and/or nausea. If you have these signs, the gas appliance may not be installed correctly, or may not be working properly.

GET FRESH AIR AT ONCE! STOP USING THE APPLIANCE IMMEDIATELY!

Some people, including pregnant women; persons with heart or lung disease, asthma, or anemia; those under the influence of alcohol; and persons at high altitudes, are more affected by carbon monoxide than others. **(The appliance must be serviced by a qualified professional service technician before use).**

34. If any soot appears on the appliance or other areas of the fireplace in which this appliance is installed, shut the system off and call a qualified professional service technician, vent-free gas burner system technician, or your local gas company.

35. This appliance may be installed in an aftermarket, permanently located, manufactured (mobile) home where not prohibited by local codes. Installation of appliances designed for manufactured homes or mobile homes must conform with *Manufactured Home Construction and Safety Standards, Title 24 CFR, Part 3280 in the U.S.*; or with *CAN/CSA Z240 MH, Mobile Housing in Canada*; or with *ANSI/NCSBCS A225.1/NFPA 501A, Manufactured Home Installations Standard* when none of the previously referenced standards are applicable.

3.0 Usage Instructions

3.1 Pre-Usage Information

Please read the information below before using this appliance. It is important that you fully understand how to operate the controls, provide adequate ventilation, and know how to safely light this product before using.

3.1.1 Guidelines

It is imperative that you maintain your unvented gas appliance by having it cleaned and serviced regularly.

This burner system is equipped with an Oxygen Depletion Sensor (ODS) safety pilot system. The ODS senses the amount of oxygen available in the room and shuts the burner system off before the oxygen level drops below 18%.

The pilot can only be relit when fresh air is available. **This may require opening a window or a door to another room or cracking the damper open slightly.**

When using fireplaces, basic precautions should always be followed to reduce the risk of fire and injury to persons, including the following:

1. Read all instructions before installing or using this appliance.
2. Internal components are hot when in use. To avoid burns, do not let bare skin touch hot surfaces.

3. May be used outdoors only when NOT exposed directly to the elements.
4. To disconnect, turn controls to OFF.
5. **Do not block exhaust openings and always allow for adequate flow.**
6. Use this appliance only as described in this manual. Any other use not recommended by the manufacturer may cause fire, shock or injury to persons.
7. SAVE THESE INSTRUCTIONS

WARNING!

Do not operate this appliance if damaged or has malfunctioned. Call a qualified service technician to inspect it. Replace any part of the system as necessary before reuse.

3.2 Operating This Appliance Safely

Please read the information below carefully before operating your unvented gas appliance. This appliance must be operated correctly to prevent loss or damage.

1. Make sure there is adequate combustion and ventilation air when this gas appliance is operating. You may need to crack damper or open window slightly.
2. **THIS APPLIANCE MUST BE MAINTAINED IN A WELL-CLEANED CONDITION AT ALL TIMES. REGULAR (AT LEAST ONCE PER YEAR) CLEANING OF THE BURNER AND ODS PILOT IS REQUIRED BY A QUALIFIED PROFESSIONAL SERVICE TECHNICIAN.**
3. To light this appliance, it may be necessary to purge the unit for longer than one minute after long periods of non-use.
4. If you operate this vent-free gas appliance fueled by LP, operating characteristics may vary as the fuel is the tank approaches empty (**less than ¼ full**). Sooting and other increases in combustion by-products will occur. If this happens, turn off the appliance, refill the LP tank, and have the burner cleaned.

5. During manufacturing, various parts of this unit are treated with oils or paints. Though not harmful, they may produce annoying smoke and smells as they are burned off during initial operation. This is a normal occurrence. Initial break-in period should last four to six hours; maximum ventilation should be provided by opening windows, doors, or chimney flue.
6. If the gas quality is poor or pressure low, your ODS pilot may not stay lit, the burners may produce soot, or the unit may backfire. Contact your local gas supplier immediately.
7. **This appliance is designed for adults to be present while in operation. Do not leave this unit burning when unattended or while anyone is sleeping. This is an attended appliance.**
8. Burning candles, air fresheners and sprays will cause objectionable odors to be created by the unvented burner system.

3.3 Lighting Instructions

FOR YOUR SAFETY. READ BEFORE LIGHTING

WARNING

If you do not follow these instructions exactly, a fire or explosion may result, causing property damage, personal injury or loss of life

Do not use this appliance if any part has been underwater. Immediately call for a qualified professional service technician to inspect the appliance and to replace any part of the control system and any gas control that has been underwater

BEFORE LIGHTING, smell around the gas burner system area for gas. Be sure to smell next to the floor, as some gas is heavier than air and will settle on the floor. **IF YOU SMELL GAS, FOLLOW INSTRUCTIONS ON THE COVER PAGE OF THIS MANUAL.**

Use only your hand to push in or turn gas control knobs. Never use tools. If a knob will not push in or turn by hand, don't try to repair it. Call a qualified

professional service technician. Forcing any controls or attempting repairs may result in fire or explosion.

For each of lighting options described below, adjust the gas flow to have the appearance and flame height as shown in Figure 1. It is important to have a flame that is balanced with glowing embers on the bottom and flames that do not extend too much above the logs. Observe the flames. The main burner flames should be blue at the base and a combination of blue/yellow at the body and the tips. They should be 5" to 8" above the logs, with the center flame being the tallest. Front flames in the ember burner should be 1/4" above the embers.



Figure 1

NOTE: The Grand Canyon Gas Logs burner system uses an Oxygen Depletion Sensing (ODS) pilot as shown in Figure 2 (Millivolt) and Figure 3 (Variable Control & Variable Electronic). When starting the ODS pilot, follow the instructions that pertain to your log set model exactly.

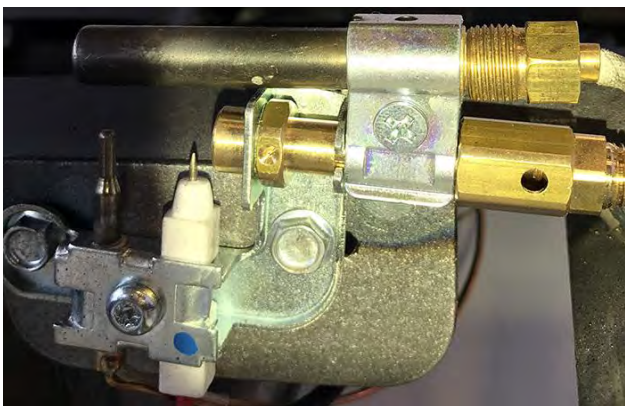

Figure 2

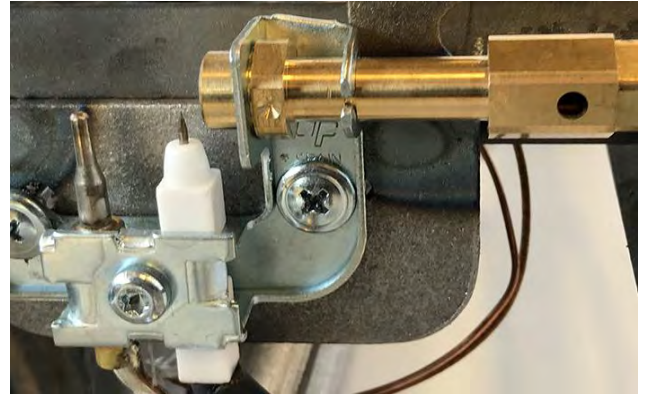

Figure 3

The angle of the pilot flame touching the thermocouple, as set by the factory, is very important to maintain. The alignment and orientation of the ODS pilot is slightly different when the burner is equipped for Natural or Propane gas sources (Figure 4). This should be checked periodically while the pilot is on.

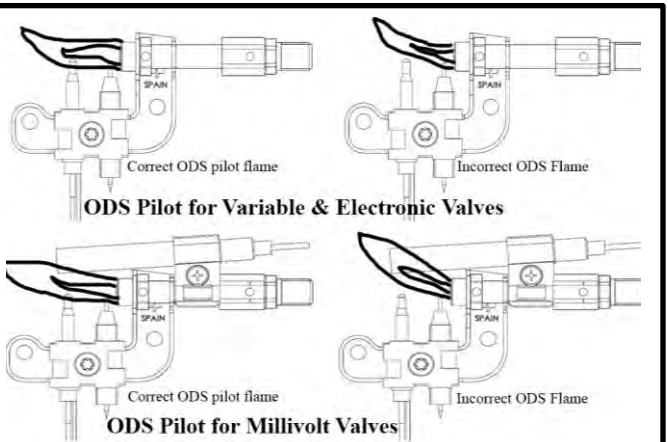



Figure 4

3.3.1 Lighting Instructions, Millivolt

In this section, refer to Figure 5 for the gas valve and Figure 6 for the remote control while performing the following lighting steps for the Millivolt burner system:

1. On the side of the burner, locate the Control Knob marked "OFF-PILOT-ON".
2. Make sure that the Control Knob is on the "OFF" position.

3. Verify that no gas is present around the fireplace or burner area (this could take 5 minutes to clear if present).
4. If you still detect gas **STOP!** Then follow the “**WHAT TO DO IF YOU SMELL GAS**” instructions found on the cover page of this manual.
5. Turn the Control Knob counterclockwise  to the “PILOT” position and press down & hold for about 5 seconds (only pilot gas will flow).
6. Continue holding the Control Knob while pressing the Piezo Ignitor button on the front of the burner assembly.
7. Keep the Control Knob pushed in for a minimum of 10 seconds after the pilot has lit, then release.
8. **Note:** When lighting the ODS pilot, it may take as much as 30 seconds for gas to reach the pilot.
9. If the ODS pilot does not hold after releasing the Control Knob, try again. If the flame still doesn't hold after several tries **STOP!** The gas valve needs to be serviced by a Certified Repair Tech.
10. Once the ODS pilot stays lit, turn the Control Knob counterclockwise  to the “ON” position.
11. Use the ON and OFF buttons on the remote control to turn the flame on and off. Note that the Signal Light should come on when a button is pressed.
12. If there is no main flame ignition in response to commands from the remote control, try again.
13. If no main flame ignition can be achieved **STOP!** The gas valve needs to be serviced by a Certified Repair Tech.

NOTE: The gas valve is equipped with an independent auto pilot safety valve. If the pilot is not operating at a full steady output (low gas, drafts, or low oxygen), the auto pilot valve will shut off due to loss of heat to the thermopile or thermocouple and the flame will require re-lighting.

If you expect to not use the burner for an extended period of time, turn the Control Knob to the “OFF” position to completely extinguish the ODS pilot and

main burner. Then shut off the gas supply line valve to the fireplace.

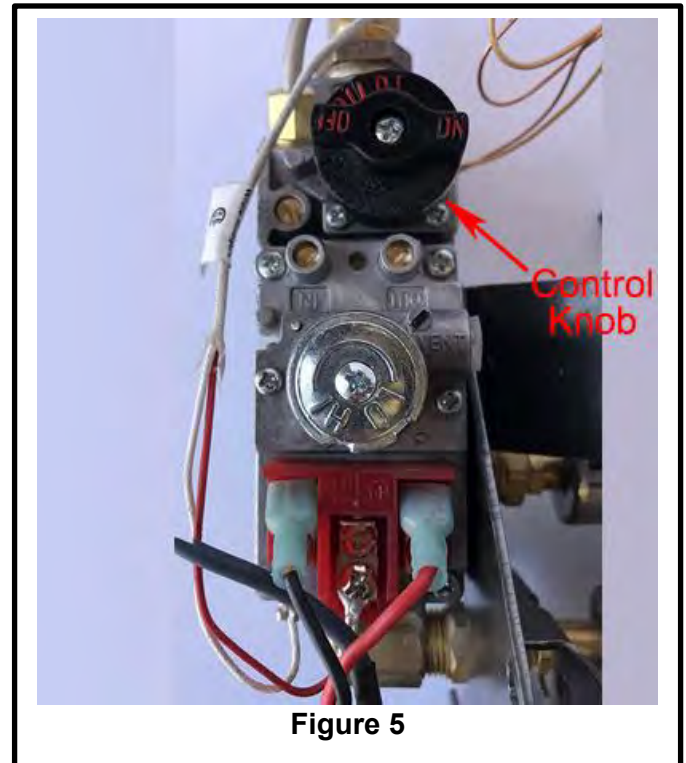

Figure 5

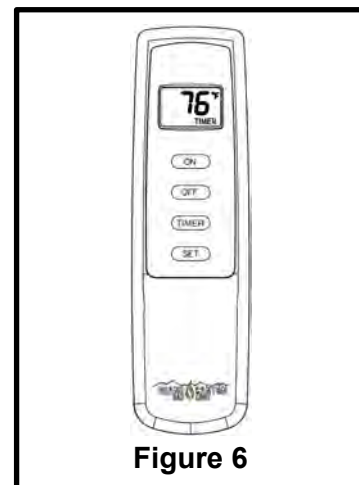







Figure 6

3.3.2 Lighting Inst., Variable Control

In this section, refer to Figure 7 for the gas valve and Figure 8 for the remote control while doing the following lighting steps for the Variable Control burner system:

1. Turn the Flame Height Control Knob (bottom knob) clockwise  as far as it will go to reach the “OFF” position.
2. Verify that no gas is present around the fireplace or burner area (this could take 5 minutes to clear if present).
3. If you still detect gas **STOP!** Then follow the “**WHAT TO DO IF YOU SMELL GAS**” instructions found on the cover page of this manual.
4. Turn the Pilot Ignitor Knob (the top knob) counterclockwise  to the “IGN” (ignition) position.
5. While in the “IGN” position, push the knob in as far as it will go. This action releases gas flow to the ODS pilot.
6. While still holding in the Pilot Ignitor Knob in, turn it counterclockwise  to the “PILOT” position.
7. This will click, then activate the spark ignitor on the pilot and cause a spark at the pilot which will ignite the pilot gas.
8. If the spark does not work after repeating steps 5-7, light the pilot with a match.
9. **Note:** When lighting the pilot, it may be necessary to push the Pilot Ignitor Knob in for as much as 30 seconds to allow gas time to reach the pilot before it will light.
10. Continue to hold the Pilot Ignitor Knob in all the way for about 30 seconds after the pilot is lit.
11. Release the knob and it will pop back out. The pilot should remain lit. If it goes out, repeat steps 4 thru 7.
12. **Note:** If the knob does not pop up when released, **STOP!** The gas valve needs to be serviced by a Certified Repair Tech.
13. **Note:** If the pilot does not stay lit after several tries, turn the gas control knob “OFF” and **STOP!** The gas valve needs to be serviced by a Certified Repair Tech.

14. Turn the Flame Height Control Knob (bottom knob) counterclockwise  to “ON”. Then turn the Flame Height Control Knob clockwise  to verify that the correct flame height may be properly controlled.
15. Turn the Flame Height Control Knob to the OFF position

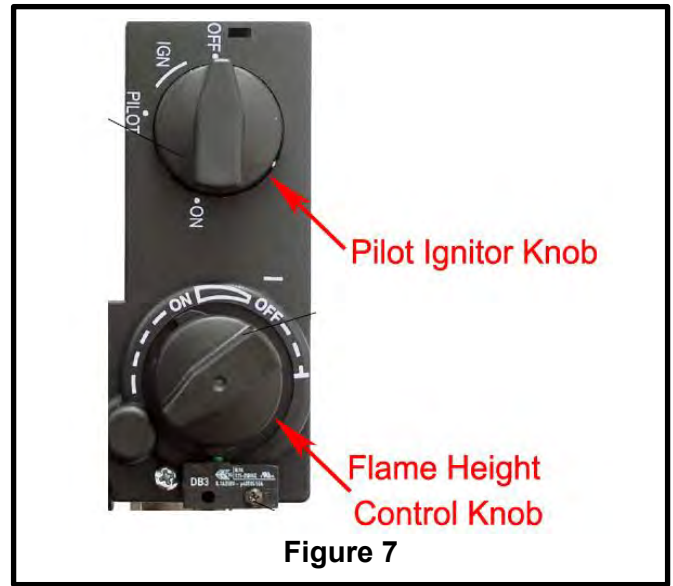

Figure 7

Now that the flame control has been verified, refer to the next section to use the remote control to control the burner. With the remote, the flame may either be adjusted manually using buttons or automatically using a thermostatic setting.

IMPORTANT: The Flame Height Control Knob has an interlock device. After shutting off all gas flow, the pilot burner cannot be relit until the thermocouple has cooled (Approx.60 sec.). The Flame Height Control Knob is designed to be operated by hand. DO NOT use any tools during this operation. Damaged knobs may result in serious injury.

If you expect to not use the burner for an extended period of time, turn both knobs to the “OFF” position to completely extinguish the ODS pilot and main burner. Then shut off the gas supply line valve to the fireplace.

3.3.2.1 Manual Mode

To operate the system in the “MANUAL MODE” do the following:

TURNING THE FLAME ON

1. Press and hold the ON/HI key until the flame comes on and reaches the desired flame height or is burning at full on.
2. Initially, the display will show "HI", but after 3 seconds it will default to display the room temperature and the word "TEMP" will be shown.

TURNING THE FLAME OFF

1. Press and hold the LO/OFF key until the flame reaches the desired flame height or completely shuts off.
2. Initially, the display will show "LO", but after 3 seconds, the display will default to show the room temperature and the word "TEMP" will be shown.

Note: The "Flame" icon will show on the display when in Manual Mode.

3.3.2.2 Thermostat Mode

The remote control can be used to thermostatically control the flame height to automatically set the room temperature.

To operate the system in the "THERMOSTAT MODE", and set a desired room temperature, do the following:

SETTING DESIRED ROOM TEMPERATURE

1. Press the MODE key until the display shows the word "ROOM"; the remote is now in the Thermostat Mode.
2. Press and hold the SET key until the desired set temperature is reached. (The display will show temperature numbers increasing from 45F to 99F, then restarting over at 45F.)
3. When the desired temperature shows on the display, release the SET key.
4. Initially, the display will show the temperature that has been set, but after 3 seconds, the display will flash the set temperature for 3 more seconds.
5. Then, the display will default to show the room temperature.

Note: The word "ROOM" will show on the display when in Thermostat Mode.

TO CHANGE THE SET TEMPERATURE

To make a change to an existing temperature setting, start at Step 2 in the previous instructions for "SETTING DESIRED ROOM TEMPERATURE".

NOTE: The highest SET temperature is 99 degrees Fahrenheit (32 degrees Celsius) and the lowest temperature is (45 Degrees Fahrenheit (6 degrees Celsius)

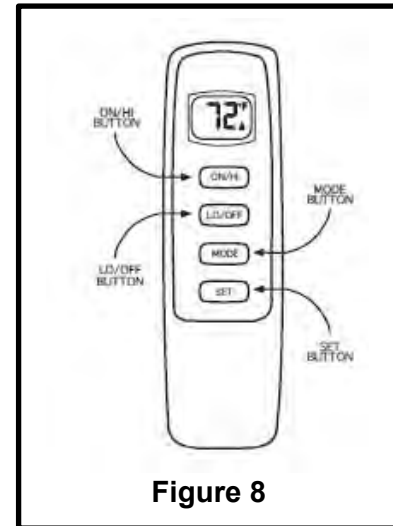

Figure 8



3.3.3 Lighting Instr., Variable Electronic



In this section, refer to Figure 9 for the gas valve and Figure 10 for the remote control while doing the following lighting steps for the Variable Electronic burner system:

1. Verify that the Main Valve Knob is in the "OFF" position.
2. Verify that the Manual Knob is in the "ON" position.
3. Verify that the On/Off Switch is in the "I" (ON) position.
4. On the remote control, Hold the "ON/OFF" button down until you hear two beeps. This will automatically light the pilot and turn the Main Gas Knob to the "ON" position.
5. You should hear the spark ignitor attempting to light the pilot and before gas flows to the burner.

6. If the burner does not light after a maximum of 60 seconds **STOP!**, TURN OFF GAS SUPPLY and get assistance from qualified service personnel.
7. When pilot ignition is confirmed, the burner will be at maximum flame height.
8. Hold down the “-“ sign (Flame Down Button) to decrease & the “+“ sign (Flame Up Button) to increase the flame height.
9. Double-clicking “+“ sets the flame to max height.
10. Double-clicking “-“ sets the flame to min height.
11. Holding the “-“ until the flame goes out leaves the pilot on and puts the burner in Standby Mode.
12. Hold the “ON/OFF” button down until you hear a single beep to turn the valve completely OFF.

In the event the remote control’s transmitter or valve control receiver fails to operate, follow these steps to **light the fireplace manually**:

1. Make sure the Main Valve Knob (bottom knob) is fully clockwise  to the OFF position.
2. Make sure the Manual Knob is fully clockwise  to the “MAN” position.
3. Make sure the “On/ Off” Switch is in the “O” (OFF) position.
4. Verify that no gas is present around the fireplace or burner area (this could take 5 minutes to clear if present).
5. If you still detect gas **STOP!** Then follow the “**WHAT TO DO IF YOU SMELL GAS**” instructions found on the cover page of this manual.
6. Place On/Off Switch in the “I” (ON) position.
7. Using a pen or appropriate small tool, push the Manual Pilot Valve all the way in and hold. This starts the flow of gas to the pilot.
8. **Note:** When lighting the pilot, it may take as much as 30 seconds for gas to reach the pilot.

9. While still pushing the Manual Pilot Valve, push in the Piezo Ignitor to ignite the pilot.
10. Wait 10 seconds after the pilot is lit, then release the Manual Pilot Valve.
11. If the pilot does not stay lit when you release the Manual Pilot Valve, wait five (5) minutes and repeat the above steps.
12. Turn the Manual Knob counterclockwise  until it is in the “ON” position.
13. Turn the Main Valve Knob all the way counterclockwise  to the “ON” position.
14. If the burner does not light **STOP!**, TURN OFF GAS SUPPLY and get assistance from qualified service personnel.
15. Use the Main Valve Knob to adjust the flame to the desired height.

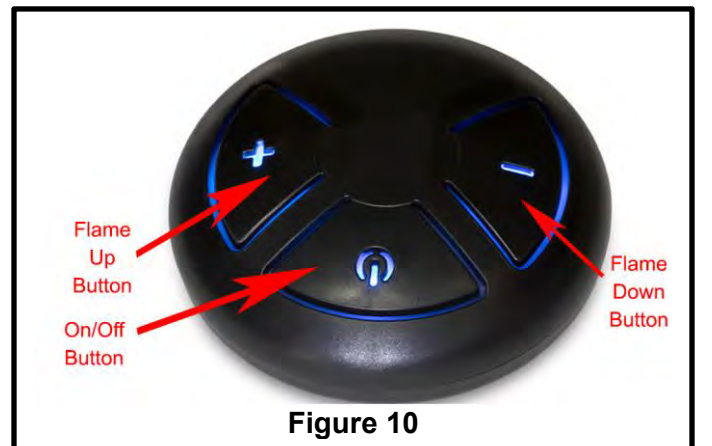
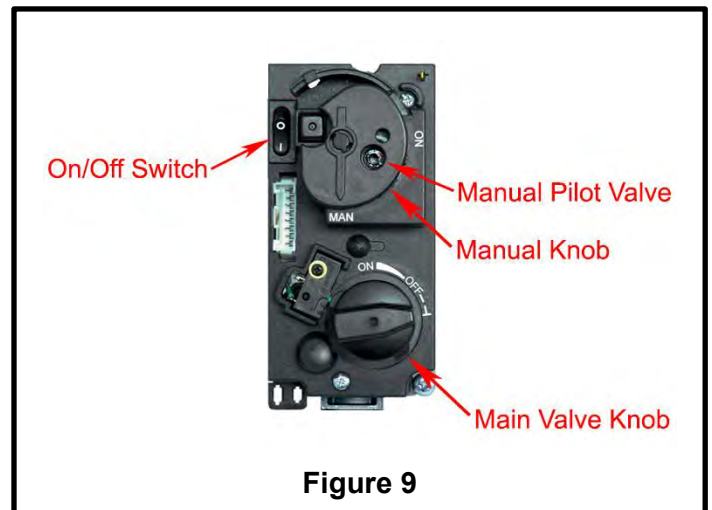

If you expect to not use the burner for an extended period of time, turn the Main Valve Knob to the “OFF” position, turn the Manual Knob to the “MAN” position, and turn the On/Off Switch to the “O” position. This will completely extinguish the ODS pilot and main burner. Then shut off the gas supply line valve to the fireplace.

3.4 Cleaning and Servicing

It is imperative that you maintain your unvented gas appliance by having it cleaned and serviced regularly. A qualified professional service technician shall inspect and service this unit at least annually.

Failure to provide reasonable and necessary maintenance as outlined in the owner’s manual will cause your appliance to malfunction and will void your warranty.

If the flames show any unusual shapes or behavior, or the burner fails to ignite properly, then the burner holes may require cleaning.

WARNING: TURN OFF VENT FREE BURNER SYSTEM AND ALLOW TO COOL BEFORE CLEANING OR SERVICING.

3.4.1 Monthly Cleaning

1. If removing logs, when reinstalling, refer to “LOG PARTS LIST” for correct log placement
2. Do not use cleaning fluids to clean logs or any part of the system.
3. Brush logs with a soft bristle brush or vacuum with brush attachment.
4. Vacuum loose particles and dust from the front and rear burners, gas controls, ignition control and grate.
5. Inspect and clean ODS pilot and accumulation of lint at burner ports.
6. Verify flame pattern and log placement for proper operation
7. Verify smooth and responsive ignition of main burner and rear burner

4.0 Pre-Installation Instructions

4.1 General

BEFORE PROCEEDING, CAREFULLY READ ALL OF THE IMPORTANT SAFETY INFORMATION CONTAINED IN THIS OWNER'S MANUAL, INCLUDING:

- Pre-Installation and Fireplace Preparation Safety Guidelines
- Ventilation and Confined Space Information
- Installation Safety Guidelines

IMPORTANT

Be sure you have read and understand all safety precautions and warnings contained in this manual.

Read these instructions carefully and completely before starting installation of the burner system.

Installation and service must be performed by a qualified professional service technician, service agency or the gas supplier.

The Grand Canyon Gas Logs burner system must be installed by a qualified professional service technician. Instructions must be followed carefully to ensure proper performance and full benefit from the burner system. **Fireplace floor must be level, clean, and smooth.**

Important: When a stainless-steel burner system is installed outdoors, ensure it is not directly exposed to the elements (precipitation, rain, wind etc.).

This appliance may be installed in an aftermarket, permanently located, manufactured (mobile) home where not prohibited by local codes.

This appliance is only for use with the type of gas indicated on the rating plate. This appliance is not convertible for use with other gasses.

4.2 Pre-Installation Precautions & Safety
CAUTION: Installation and repairs must be done by an NFI certified or another qualified professional installer.

Installer: Carefully read these instructions before installing this gas burner system. Be sure you understand all safety precautions and warnings contained in this manual.

1. **CAUTION:** If not installed, serviced, and used correctly per these instructions, this product can cause serious personal injury, property damage, or loss of life.
2. Some fireplaces (especially older ones) may need repair prior to installing this appliance.
3. This appliance is only for use with the type of gas indicated on the rating plate. This appliance is **NOT CONVERTIBLE** for use with other gasses.
4. **CHECK GAS TYPE (Natural or L.P.):** the gas supply must be the same as stated on your burner system rating plate. If the gas supply is different, **DO NOT INSTALL**. Contact your dealer for immediate assistance.
5. **INSUFFICIENT GAS PRESSURE WILL KEEP THE ODS (OXYGEN DEPLETION SENSOR) PILOT FROM OPERATING PROPERLY. DO NOT USE IF GAS PRESSURE IS LOWER THAN THE MINIMUM REQUIREMENTS.**
6. The *minimum* inlet gas-supply pressure for the purpose of input adjustment is **5" water column (w.c) on natural gas and 11" w.c. LP gas.**
7. The *maximum* inlet gas-supply pressure is **10.5" w.c. on natural gas and 13" w.c. LP gas.** The LP source must be regulated. **(Do not connect this appliance directly to an unregulated LP gas tank – this can cause an explosion.) Do not connect this appliance to a portable LP gas cylinder.**

8. **The gas piping system must be sized to provide minimum pressure at the maximum flow rate (BTU/Hr).** Undue pressure loss will occur if the pipe is too small, or the run is too long. Gas supply piping must be 1/2" minimum interior diameter. If the gas line is longer than 20', a larger diameter line may be necessary. Refer to the NFPA 54 guidelines for further details.
9. Input ratings shown in BTU per hour are for elevation up to 2,000 ft. For elevations above 2,000 ft., refer to the National Fuel Gas Code or contact Grand Canyon Gas Logs before installing.

4.3 Burner System Requirements

Note: Installation in any other fireplace is prohibited and will void any approvals and warranties.

This burner system is equipped with an Oxygen Depletion Sensor (ODS) safety pilot system. The ODS senses the amount of oxygen available in the room and shuts the burner system off before the oxygen level drops below 18%.

The pilot can only be relit when fresh air is available. This may require opening a window or a door to another room or cracking the damper open slightly.

This burner system has been certified to two standards:

VENTED DECORATIVE APPLIANCE – ANSI Z21.60

UNVENTED ROOM HEATER – ANSI Z21.11.2

4.4 Vented Installation Restrictions

This unit may not be installed in a vented fireplace with a chimney of less than 15 feet in height.

This burner system may be installed as a vented decorative appliance in compliance with ANSI Z21.60 and the national Fuel Gas Code, Section 6.6. The minimum permanent free opening of the fireplace chimney or chimney damper must be met per the Chimney Vent Openings shown in Table 3.

To accomplish this, the chimney damper must be fixed in a manner to maintain permanent free opening at all times.

The damper clamp (See Figure 11) with bolt is provided as a means to prevent the full closure of the damper blade. The clamp is easily attached to most

damper blades with pliers or a wrench, and must be permanently installed. The clamp is designed to prevent accidental closure of the damper when installed as pictured.

Should the clamp not fit, or fail to provide the required permanent vent opening, do any of the following:

- Have a permanent stop installed
- Remove the damper blade
- Install a screw or bolt on the edge of the damper
- Drill holes in the damper
- Cut the damper provide the minimum permanent opening required

This damper clamp is not required if the burner system is installed as an unvented room heater.

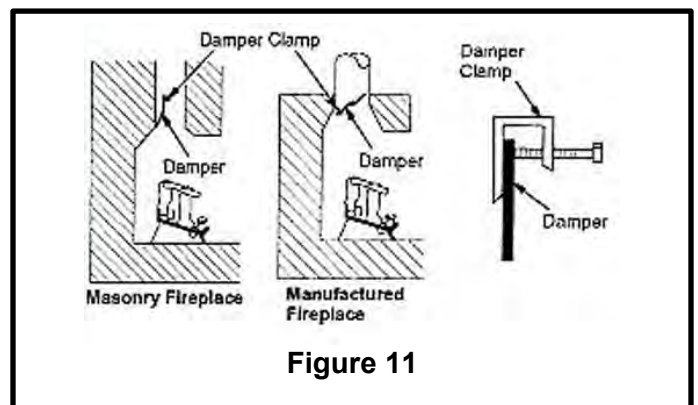

Figure 11

4.5 Unvented Installation Restrictions

Note: To install the unvented gas burner system, the fireplace must have a gas-supply line that has been installed by a qualified professional service technician in accordance with all local codes.

Check local or state codes to determine if vent-free heaters are permitted in your locality before you install this burner system as a vent-free appliance. If not permitted, you may install and operate this burner system as a vented appliance.

When installed as an unvented decorative gas appliance, your vent-free gas burner system **SHALL**

NOT BE INSTALLED IN A CONFINED SPACE OR UNUSUALLY TIGHT CONSTRUCTION unless provisions are made for adequate combustion and ventilation air.

Unusually tight construction is defined as:

1. Walls and ceiling exposed to the outside atmosphere have a continuous water vapor retarder with a rating of 1 perm or less with openings that are sealed or use gaskets;
2. Weather stripping has been added on openable windows and doors; AND
3. Caulking or sealants are applied to areas such as joints around window and door frames; between sole plates and floors; between wall-ceiling joints; between wall panels; at penetrations for plumbing, electrical and gas lines; and other openings.

4.5.1 Determining a Confined Space

- In general, the National Fuel Gas Code, ANSI Z223.1/NFPA 54 defines a confined space as a space whose volume is less than 50 cu. Ft per 1,000 BTU per hour of the aggregate input of all appliances installed in that space.
- An unconfined space is a space where the volume is at least 50 cu. Ft. per 1,000 BTU per hour of the aggregate input rating of all appliances installed in that space.
- Rooms communicating directly with space in which the appliances are installed, through openings not furnished with doors, are considered a part of the unconfined space.

WARNING: Do not install the unvented burner system where the room is considered a confined space.

To determine if the location that this burner system is to be installed fits the definition of an unconfined space, multiply the length of the room by the width of the room by the height of the room then multiply by 20. The result is the maximum BTU's allowed.

(Per Figure 12, calculate Length x Width x Height x 20 = Maximum BTU's Allowed)

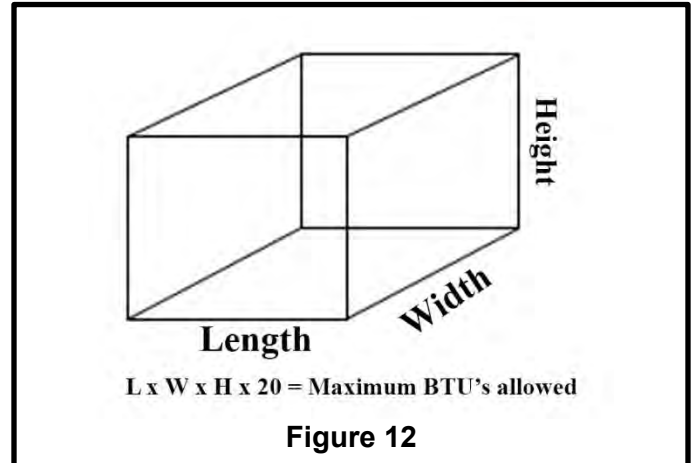

WARNING

If the area in which the heater may be operated is smaller than that defined as an unconfined space of if the building is unusually tight construction, provide adequate combustion and ventilation air by one of the methods described in the National Fuel Gas Code, ANSI Z223.1/NFPA 54, Air Combustion and Ventilation, or applicable local codes.

REMEMBER

L x W x H x 20 = MAXIMUM BTU's ALLOWED

4.5.2 Installing in a Confined Space

If the space is smaller than the above formula allows, and/or smaller than the diagrams, **DO NOT** install the vent-free burner system unless provisions for additional combustion and ventilation air are made.

IT MAY BE NECESSARY TO OPEN A WINDOW SLIGHTLY (1"-2") OR OTHERWISE INCREASE VENTILATION. CONDITIONS REQUIRING THIS INCLUDE, BUT ARE NOT LIMITED TO:

1. Installation in a **CONFINED SPACE**
2. Installation in a of **HOME UNUSUALLY TIGHT CONSTRUCTION**
3. Installation at **HIGH ALTITUDES**
4. Certain **MEDICAL** or **PHYSICAL CONDITIONS OF THE HOMEOWNER** that may be adversely impacted by combustion products created by burning natural or propane gas.

Installation in a home with unusually tight construction and / or installation at high altitudes may cause your vent-free burner system to produce

excessive heat or excessive moisture. The oxygen depletion sensor may shut down the burner system.

These conditions may be corrected by opening a window or otherwise increasing the number of air changes in the home.

This vent free burner system has been certified to function safely and reliably with emission by-products well within acceptable safety and health standards.

Your specific medical or physical condition may render you more sensitive to products created by burning natural gas or propane gas. If this is the case, you should open a window or otherwise increase ventilation.

4.6 Clearances to Combustibles

If the vent-free burner system is installed in a factory-built fireplace, follow the manufacturer's guidelines for minimum clearances to combustibles.

In the absence of such guidelines, refer to the illustration of clearances in Figure 13 and follow the instructions below:

Clearances to Combustible Construction:

Sidewalls: 6" from side of fireplace opening.

Ceiling: 42" from top of fireplace opening.

Flooring: See IN FRONT OF FIREPLACE below.

Mantel: See ABOVE THE FIREPLACE below.

Note: Clearances to combustible construction are those distances required to ensure that fireplace mantels, facings, walls, ceilings, and flooring will not catch fire.

In most cases, these clearances should also be adequate to prevent discoloration or warping due to heat. However, every gas burner installation presents a different and unique set of circumstances involving many variables beyond the control of the manufacturer.

These include paint or finish composition, previous exposures to heat, methods and quality of construction, air flow patterns, glass doors, fans or blowers, etc.

Because of these variables, we cannot guarantee that heat warping or discoloration will never occur.

The potential for heat warping or discoloration may exist no matter what item(s) you are burning in the fireplace, including wood.

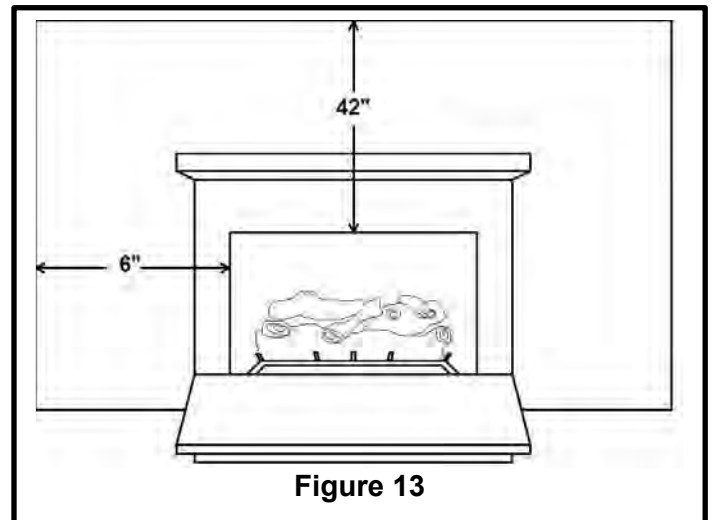

These dimensions are **MINIMUM CLEARANCES** to maintain when you install this burner system. The fireplace opening **MUST BE AT LEAST 6"** from any combustible sidewall. The ceiling **MUST BE AT LEAST 42"** from the top of the fireplace opening.

4.6.1 Clearance IN FRONT

Be certain that combustible flooring material (i.e. carpet, tile, etc.) is not too close to the vent free unit.

If the vent-free burner system is at floor level or less than 6" above the floor, there MUST be at least 12" (1 foot) of noncombustible material between the front of the fireplace and any combustible flooring.

4.6.2 Clearance ABOVE

To install the vent-free burner system, there must **ALWAYS** be noncombustible or heat resistant material immediately above the fireplace opening. Heat resistant material (i.e. marble, or slate) must be at least 5/8" thick. Sheet metal should not be installed onto combustible materials.

If you **DO NOT** install a fireplace hood, there **MUST** be at least **12"** of noncombustible or heat resistant material immediately above the fireplace opening.

If you **DO** install a fireplace hood, there **MUST** be at least **10"** of noncombustible or heat resistant material immediately above the fireplace opening.

If there is a wooden mantel, shelf or other combustible projection above the fireplace, follow the clearances information in Figure 14.

A fireplace hood deflects heat away from the fireplaces face and mantel, reducing the potential for heat related warping or discoloration. The use of a fireplace hood is highly recommended.

DO NOT place any combustible decorations/items on the mantel or above the fireplace.

IF YOU CANNOT MEET THESE MINIMUM CLEARANCES, YOU MUST OPERATE THE VENT-FREE BURNER SYSTEM WITH THE CHIMNEY FLUE DAMPER OPEN.

4.7 Fitting the Unit

4.7.1 Location

This unit may be installed at any indoor location. However, when choosing a location, please keep in mind the following guidelines:

- Install out of direct sunlight for maximum performance.
- Select a suitable location that is not susceptible to moisture and is a safe distance from flammable items like drapes, furniture or high-traffic areas.
- If installed in an outdoor location, shelter from exposure to the elements.

4.7.2 Mounting Clearances

Observing minimum fireplace dimensions and centering the appliance in the fireplace will ensure adequate clearance for operation and servicing.

It may be necessary to disconnect the unit for some types of service in the future. Therefore, please keep this mind when arranging connections so that they have adequate clearances for easy access later.

4.7.3 Optional Chimney Venting

Refer to Table 3 for chimney sizing requirements if the burner is to be installed as a vented appliance.

Minimum Permanent Chimney Vent Opening In sq. in (when used as a vented appliance)		
Factory built fireplaces – For masonry-built fireplaces, add 10 sq.in. to amount shown.		
Chimney Height	18"	24/30"
15'	15	17
20'	13	14
25'	12	12
30'	11	11
Table 3		

4.7.4 Product Installation Illustration

Refer to the product photo and installation illustration shown in Figure 15. A front view of the fireplace illustrated depicting the details of the measuring points for dimensions.

The illustration also shows the burner assembly as it appears when placed in a fireplace in a fully centered position.

These illustrations show how dimensions that are provided in this manual relate to the minimum size fireplace that must be used to install the gas logs.

4.7.5 Product Dimensions

See Table 1 in the Introduction section for the dimension requirements for each model. Use this table to determine the fireplace dimensions necessary for the installation.

IF YOU CANNOT MEET THESE MINIMUM CLEARANCES, YOU MUST OPERATE THE VENT FREE GAS BURNER SYSTEM WITH THE CHIMNEY DAMPER OPEN

Mantel Without Hood

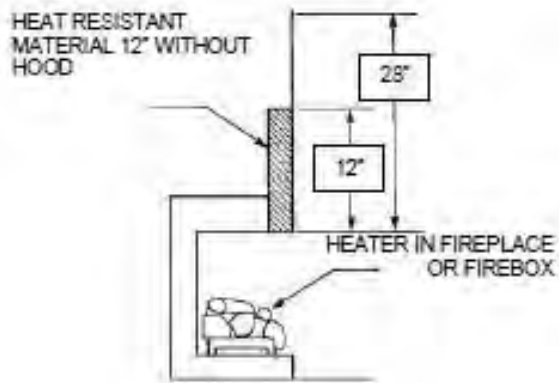

Mantel With Hood

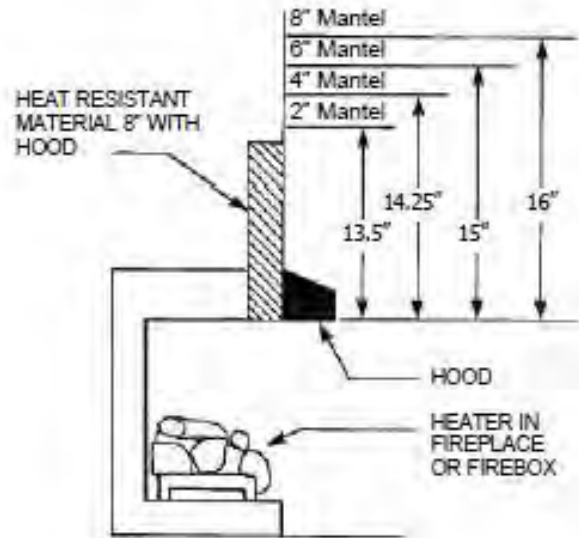

Figure 14

Fireplace Dimensions

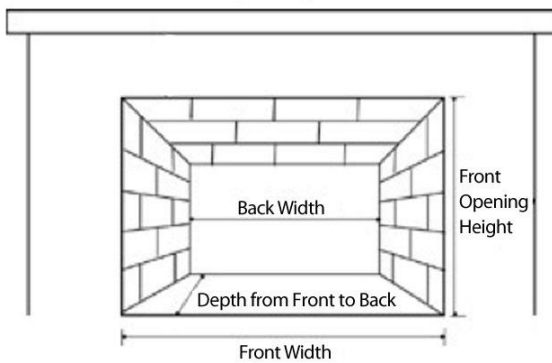

Figure 15

4.8 Preparation

4.8.1 Unpacking

Follow the procedure below to unpack and inspect the unit:

Carefully remove the packing from around the unit and set aside parts that are wrapped separately.

Check that all parts and accessories are accounted for before disposing of any packaging.

If necessary, keep the original packaging for future transport and/or storage.

Refer to Figures 16-18 to review the general contents of the packaging for the Millivolt, Variable Control, and Variable Electronic models. Note that the appearance of the burner, gas valve, and remote control are different for each model.





Figure 18

4.8.2 Gas Connections

WARNING:
Do not connect this appliance to a high-pressure natural gas line or unregulated propane tank.

CHECK GAS PRESSURE (natural or propane). The gas supply must be the same as stated on the burner system rating plate. **If the gas supply is different, DO NOT INSTALL.** Contact the dealer for immediate assistance.

5.0 Installation

WARNING: Failure to position internal parts in accordance with the installation diagrams or failure to use only parts specifically approved with this unvented burner system may result in property damage or personal injury.

5.1 Installation Safety Information

1. Carefully inspect the burner and log cartons for shipping damages. If any parts are missing/damaged, call your dealer. **Do not attempt** to install the appliance unless all parts are in good condition.
2. Correct installation of the ceramic refractory log sets and proper placement and installation of the burner assembly, including ember placement and lava rock placement, are imperative to safe operation of your set. Problems **WILL** occur if all items are not properly installed. Reference the **INSTALLATION** section, **LOG PLACEMENT**.
3. When installing in a wood-burning fireplace, center the appliance in the fireplace while making certain that no part of the assembly protrudes (forward) beyond the fireplace face. **DO NOT PUSH THE UNIT ALL THE WAY TO THE BACK.**
4. If you use lava rock or glass, for decorative use, do not allow these accessories into or onto any part of the burner or logs. Lava rock or glass used to accessorize the vent-free burner, should only be placed on the floor of the fireplace, in front of and to the sides of the burner, but away from the controls.
5. DO NOT PLACE logs or accessories, such as vermiculite, glass or other foreign items on this appliance. These items will cause improper burning, sooting, and/or high levels of carbon monoxide. Additional logs and/or accessories may be placed around the burner system, as long as they do not interfere with the burning of the gas appliance.

6. Connecting directly to an unregulated LP tank can cause an explosion.
7. Special care is required if you are installing the unit into a **SUNKEN FIREPLACE**. You must raise the fireplace floor to allow access to gas controls. This will ensure adequate airflow and guard against sooting. Raise the fireplace floor using noncombustible materials.

5.1.1 Fireplace Floor Requirements

DO NOT install this burner system if the fireplace hearth is recessed. The fireplace floor must be at the same level as or larger than the fireplace front opening. An ash lip or recess may not exceed $\frac{3}{4}$ ". See Figure 19 below.

Note: If glass doors are used, the fireplace floor must not be blocked by the door frame; the frame must have openings to allow for fresh air circulation during combustion.

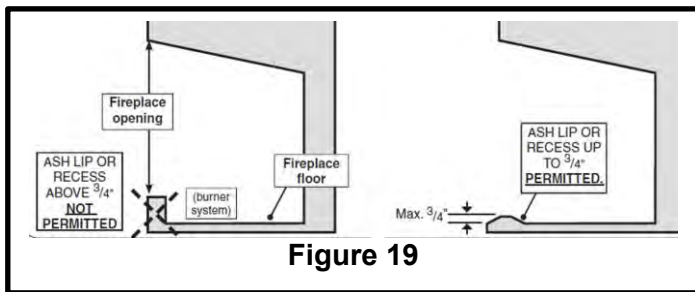

Figure 19

5.1.2 Installing the Burner Unit

REFER TO THE PARTS LIST WHEN FOLLOWING THESE INSTRUCTIONS. The 18/24/30" burner models are shown in the illustrations. Stainless steel models install in the same manner.

INSTALL BURNER:

1. MAKE SURE THE FIREPLACE GAS SUPPLY IS TURNED OFF.
2. Locate the gas-supply stub inside the fireplace and remove the cap, if attached.
3. **CAUTION:** When removing the cap, make sure the stub does not turn, loosening the connection in the wall.
4. **Be sure gas to the fireplace is turned off.** On the burner, remove the adapter that has been loosely screwed into the end of the flex connector (pre-installed on the burner system). Attach the adapter to the gas-supply stub using a pipe compound resistant to all gasses. Tighten securely.
5. In Figure 20 below, the gas supply stub is shown properly fitted with the adapter.



Figure 20

6. Place the burner system in the fireplace. Centering the burner front to back and side to side as shown in Figure 21.

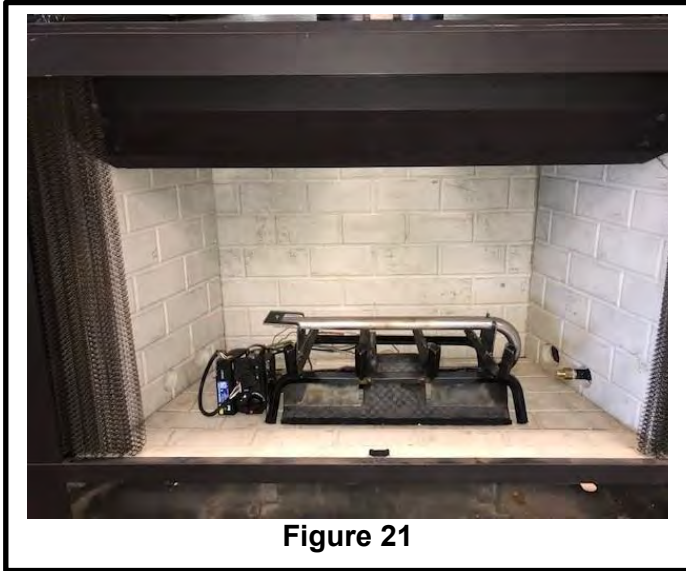

Figure 21

7. Attach the flex connector to the adapter as shown in Figure 22. Tighten securely. IF FLEX LINE IS NOT LOG ENOUGH, LONGER FLEX LINES CAN BE PURCHASED AT YOUR LOCAL HARDWARE STORE.

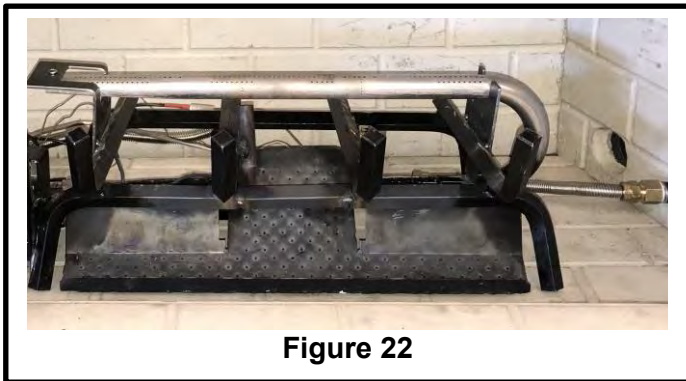

Figure 22

8. LEAK TEST: Turn on the fireplace gas supply, and test at all connections for leaks using the appropriate soapy water solutions. If bubbles appear, turn off the gas supply and re-tighten all the connections.
9. Repeat testing and tightening until no leaks are present. If the leak still remains, turn off the gas supply and contact the local gas company or dealer. NEVER USE A FLAME TO CHECK FOR LEAKS.

5.1.3 Installing the Remote Control

Before using the remote control, you must install batteries in both the transmitter and receiver, then

“pair” the transmitter with the receiver on the gas control valve before testing.

Depending on which model you have, you will use one of the 3 types of remote controls available. Pick the appropriate instructions for your model below and follow them carefully.

NOTE: The setup for the remote control is a one-time setting and is not required again, even after a building power failure or changing the transmitter or receiver batteries. However, these steps would need to be repeated if the actual transmitter, receiver, or both are ever replaced.

Use the type of batteries included with the kit for installation. Always observe polarity when installing batteries. It is recommended that the original type of batteries always be used for longer life and optimum performance.

5.1.3.1 Installing the Millivolt Remote

Install the included (2) AAA batteries in the transmitter by first sliding out the battery holder. Then, insert the battery into the battery holder with the plus (+) side up as and slide it closed as shown in Figure 23.

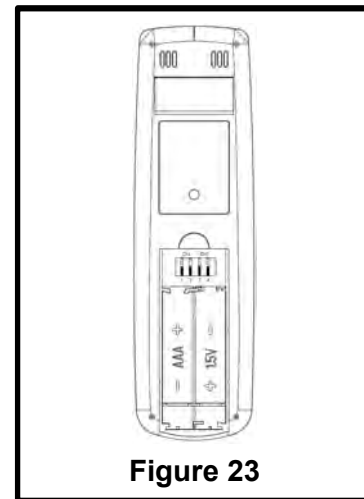

Figure 23

To set the electronic code that is used to synchronize the receiver and transmitter, please follow these steps:

1. On the back of the transmitter, there are 2 code switches. Pick a code and set both code switches to create a code combination (Figure 24) and make note of it. The same code combination will be set in the receiver later.

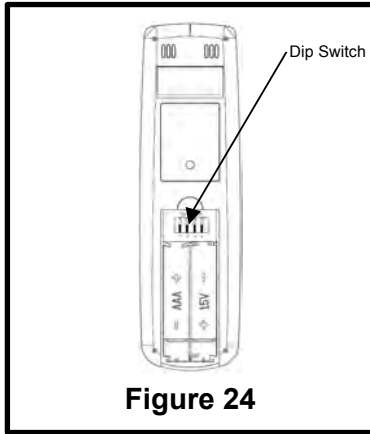

Figure 24

2. Locate the receiver that is attached to the side of the burner unit (Figure 25), detach it, slide open the cover, and insert the 4 included alkaline AA batteries by sliding open the battery cover, inserting the batteries, and sliding the cover closed.

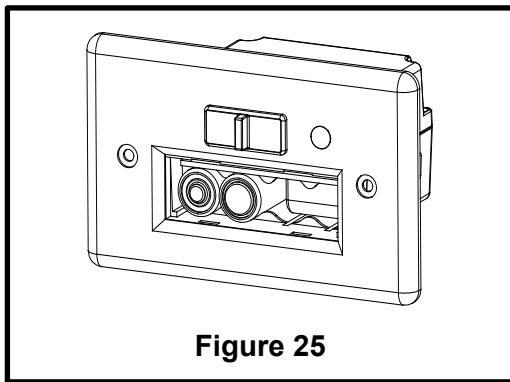

Figure 25

3. Set the same code combination, as used in the transmitter's code switches above, in the receiver, by using the receiver's code switches. Move the slide button to the "REMOTE" position (Figure 26) and place the receiver in front corner of the fireplace as far from the burner as possible.

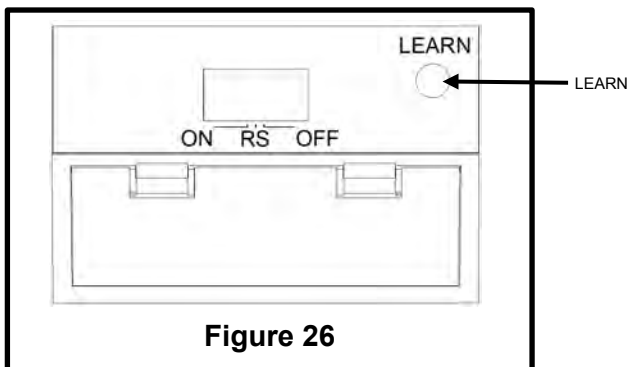

Figure 26

Proceed to the next section for burner testing.

5.1.3.2 Installing the Variable Remote

Install the included AA alkaline batteries in the transmitter by first sliding out the battery compartment cover. Then, insert the batteries in the battery compartment, while observing polarity, and slide it closed as shown in Figure 27.

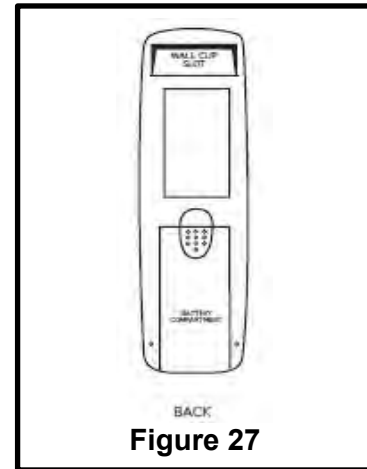

Figure 27

Locate the receiver that is attached to the side of the burner unit (Figure 28), detach it, slide open the cover, and insert the 4 included alkaline AA batteries by sliding open the battery cover, inserting the batteries, and sliding the cover closed.

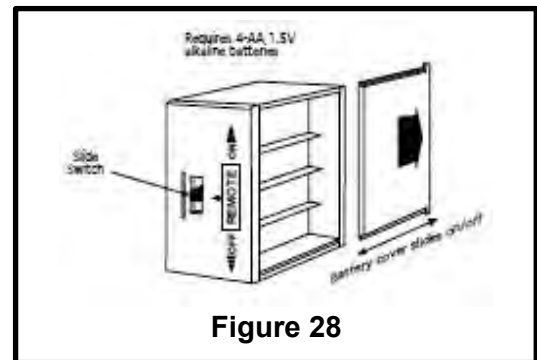

Figure 28

To set the electronic code that is used to synchronize the receiver and transmitter, please follow these steps:

1. Slide the function button on the receiver to the REMOTE position (Figure 29).

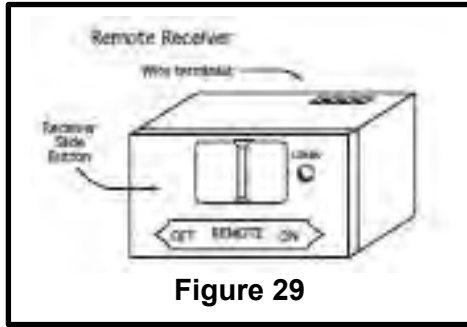

Figure 29

2. Locate the LEARN button located on the front right face of the receiver inside the small hole labeled LEARN. Then, using a small screwdriver (or end of a paperclip), gently press the LEARN button positioned inside, and release.
3. The receiver will emit a “beep”.
4. After the receiver emits the beep, press the transmitter’s OFF button, then release. The receiver will emit several beeps indicating that the transmitter’s code has been accepted and saved by the receiver.
5. Move the slide button to the “REMOTE” position and place the receiver in front corner of the fireplace as far from the burner as possible.

Proceed to the next section for burner testing.

5.1.3.3 Installing the Var. Elect. Remote

Install the included 2 AAA batteries in the “Puck” transmitter by first removing the battery compartment cover. Then, insert the batteries in the battery compartment and close it.

The remote control receiver is located on the left side the burner unit. To install the batteries, open the cover and install the included 3 AA batteries. Make sure the batteries are placed on top of the battery removal ribbon as shown in Figure 30. Replace the cover.

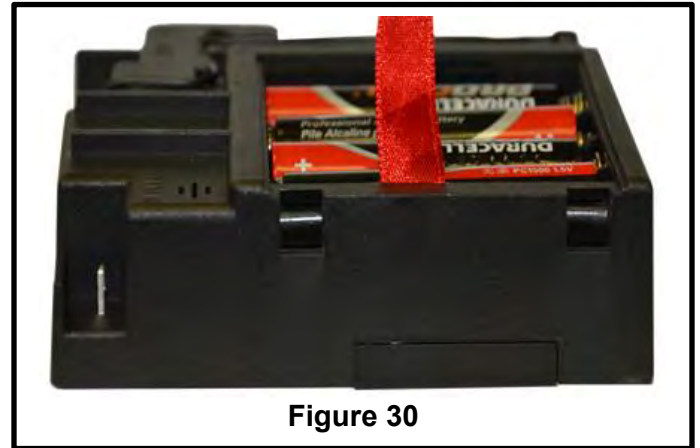

Figure 30

The pair is now ready to synchronize.

To set the electronic code that is used to synchronize the receiver and remote control, please follow these steps:

1. Locate the RESET button located on the top of the front face of the receiver inside the small hole labeled RESET (Figure 31). Then, using a small screwdriver (or end of a paperclip), gently press the RESET button positioned inside, and hold.

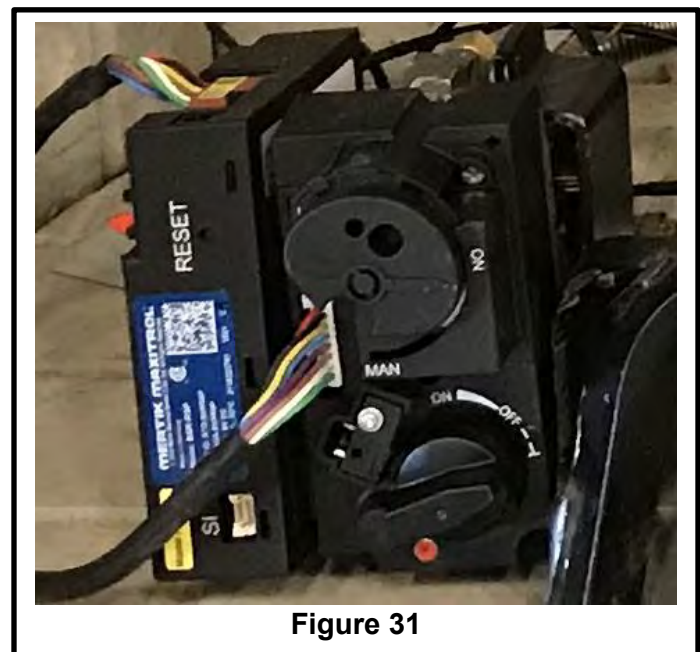

Figure 31

2. After the long beep, release the reset button.

3. Within the next 20 seconds, press the transmitter's flame down button (Figure 32) until you hear the receiver emit two short beeps confirming that the code has been set.

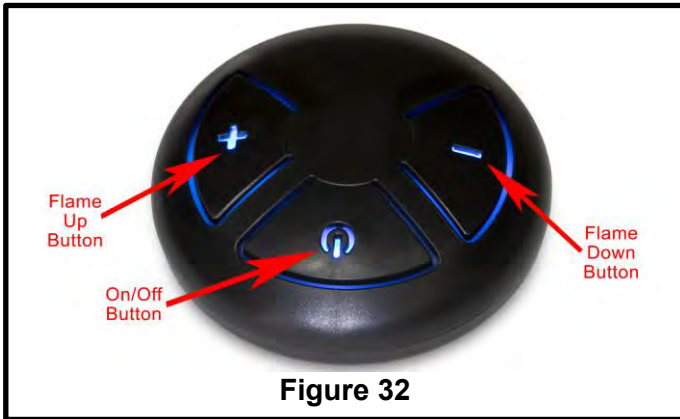

Figure 32

4. If you hear one long beep, this indicates that the code learning sequence has failed or the wiring is incorrect; please try again and check the wiring connections on the control.

5.1.4 Setting the Controls

It is recommended that before you install the decorative media, you familiarize yourself with the control valve layout and light the burner to test. This review will assist you when operating the burner system.

IMPORTANT: For all valves, the air **MUST** be purged from the gas line before the pilot will light and burn properly. The time needed to purge will depend on the length of the gas line to the unit and the amount of time since the unit and gas line was used last.

It may take several minutes before all the air is purged and the pilot will light and burn properly. Reference the LIGHTING INSTRUCTIONS in the User section of this manual for details when you are ready to light the burner.

5.1.5 Checking the Gas Pressure

AT THIS STAGE, FOLLOW THE INSTRUCTIONS BELOW TO ASSURE THAT THE GAS PRESSURE IS CORRECT.

The burner system and its main gas valve must be disconnected for the gas-supply piping system during any pressure testing of that system at test pressures in excess of ½ psi (3.5 kPa).

The burner system must be isolated from the gas-supply piping system by closing its equipment shutoff valve during any pressure testing of the gas-supply piping system at test pressure equal to or less than ½ psi (3.5 kPa). This is accomplished by closing the gas supply line valve.

IMPORTANT: Check the operating gas pressure with the system burning and the control fully **ON**. See Table 2 for Natural Gas and Propane Gas pressure information.

MILLIVOLT VALVE

Check the valve regulator pressure at the Inlet Pressure Tap referenced in Figure 33. Turn the inlet screw counterclockwise 2 or 3 turns, then place the pressure gauge tubing over the Inlet Pressure Tap. (marked IN).

After taking the pressure reading, remove the tubing, and turn the inlet screw clockwise until seated. Do not over-torque. Check for gas leaks.

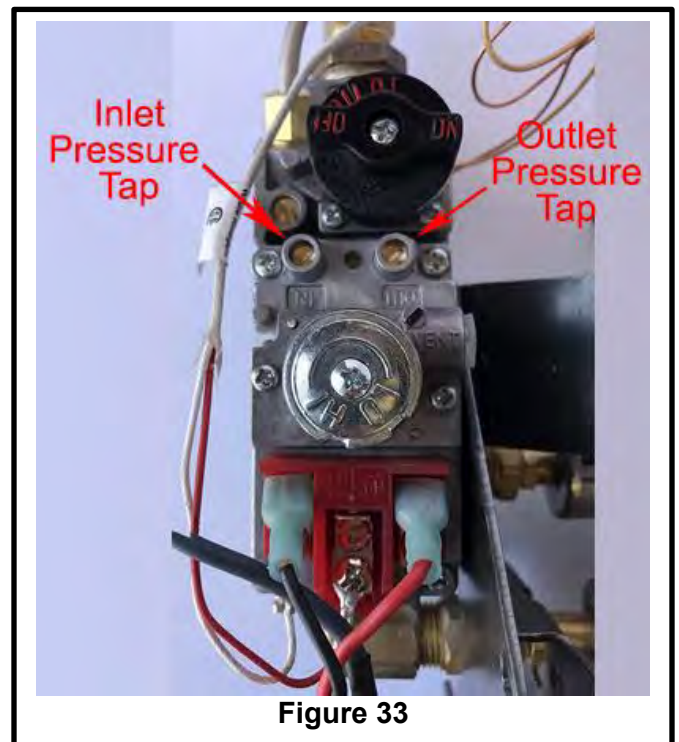

Figure 33

VARIABLE and VARIABLE ELECTRONIC CONTROL VALVES

Check the valve regulator pressure at the Inlet Pressure Tap location referenced in Figure 34. Using a small screwdriver angled up & under the

bottom right side of the valve, turn the inlet screw counterclockwise 2 or 3 turns, then place the pressure gauge tubing over the Inlet Pressure Tap.

After taking the pressure reading, remove the tubing, and turn the inlet screw clockwise until seated. Do not over-torque. Check for gas leaks.

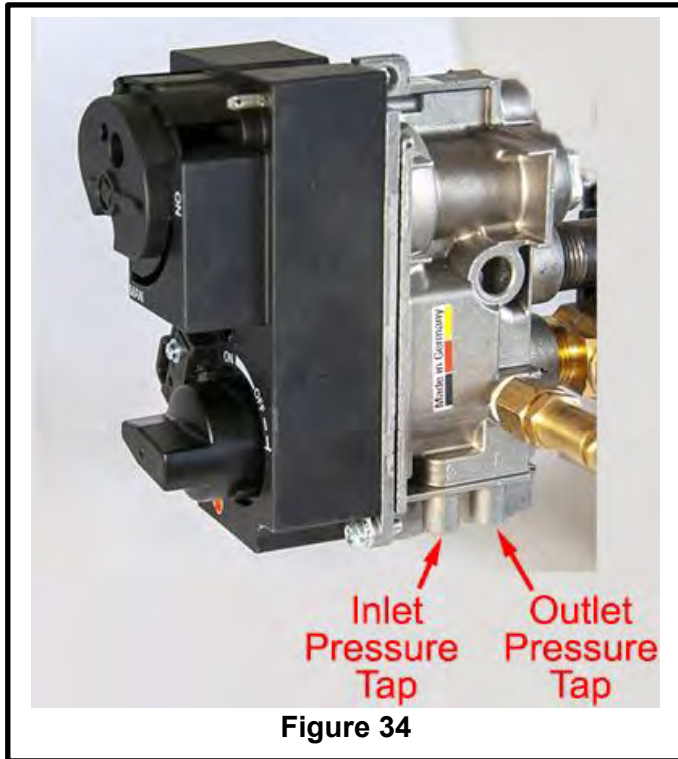

Figure 34

5.1.6 Placing Decorative Media

NOTE: Loose material shall be installed per these Instructions. Replacement loose material must be purchased directly from Grand Canyon Gas logs or a factory-authorized dealer.

Application of excess loose material may adversely affect performance of the heater.

WARNING: ALL PREVIOUSLY APPLIED LOOSE MATERIAL MUST BE REMOVED PRIOR TO REAPPLICATION.

Generally, decorative media is installed in the ember bed below and in front of the burner to achieve the desired glowing effect when the burner is lit.

This media must be close enough to the ember bed flame feed holes to get hot enough to appear as live coals. If the media needs to be repositioned after lighting, allow enough time (at least 10 minutes) for it to cool before making any changes.

5.1.6.1 Placing Glowing Embers

Glowing embers should be placed first in the ember bed in the center of the pan below the burner. Evenly distributed so as to cover all the holes in the center of the bed.

5.1.6.2 Placing Lava Rock

Next, place the lava rock evenly along front edge of the ember bed and out to the front edge of the fireplace. Be sure not to place it in the way of doors, screens, or other items needed to operate the fireplace.

5.1.6.3 Making the Media Consistent

There should be no gaps between the lava rock and the glowing embers (Figure 35). Make sure that placement is done to avoid clumping while keeping the media components butted together. This is necessary to give the coals a consistent appearance when lit. Save any unused media for possible use later.

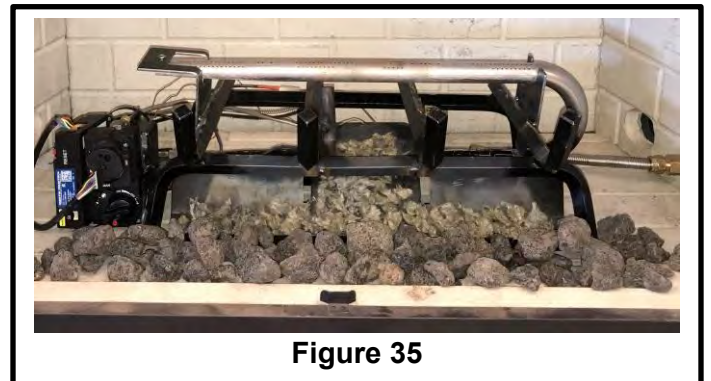

Figure 35

5.1.7 Log Set Placement

You must position and maintain the appropriate log layout to ensure optimal operation of the burner system. The 18" & 24/30" sizes use the same log styles with varied paint schemes. Design may vary slightly; placement is the same.

CAUTION: BURN HAZARD! Logs will remain hot for some time after use. If you need to reposition any log to maintain the proper layout, use heat-resistant gloves or allow logs adequate time to cool before handling.

For all log sizes, the undersides of the bottom logs have cutouts and tabs that align over the burner. **THE BOTTOM LOGS MUST BE FULLY SEATED FLAT ON THE BURNER.** Certain logs have notches

on them to allow the logs to interlock in place with other logs.

Log placement is illustrated below using a dark border around the particular logs that are being placed in each step.

5.1.7.1 18 Log Set Placement – WO/RO

Referring to Figure 36, first place the 18-inch back log into place while making sure that the grooves are tightly seated on the burner grate. Then place the 18-inch front log into place. The placement should now be as shown.

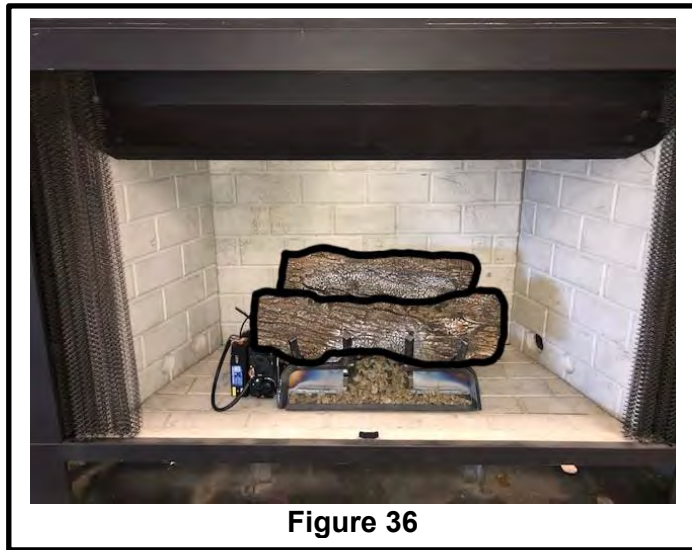

Figure 36

Carefully place the two front-to-back perpendicular logs on top as shown in Figure 37. Make sure they are stable in this position.

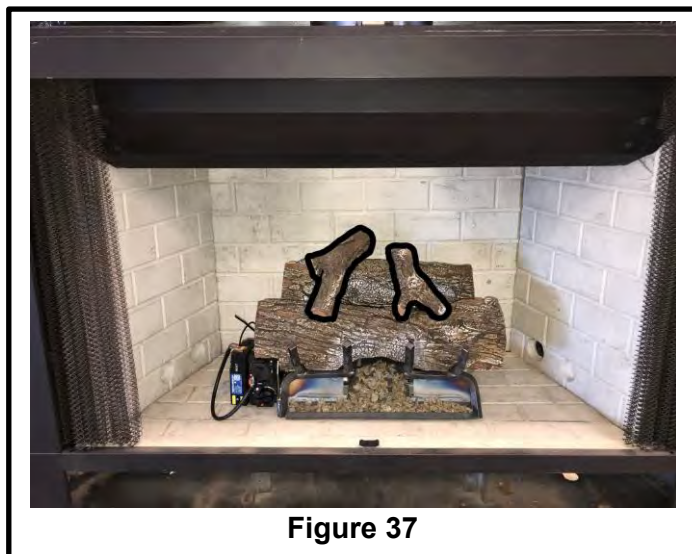

Figure 37

Place the remaining 2 parallel logs on top as shown in Figure 38. There should be a total of 4 logs on top of the burner at this point.

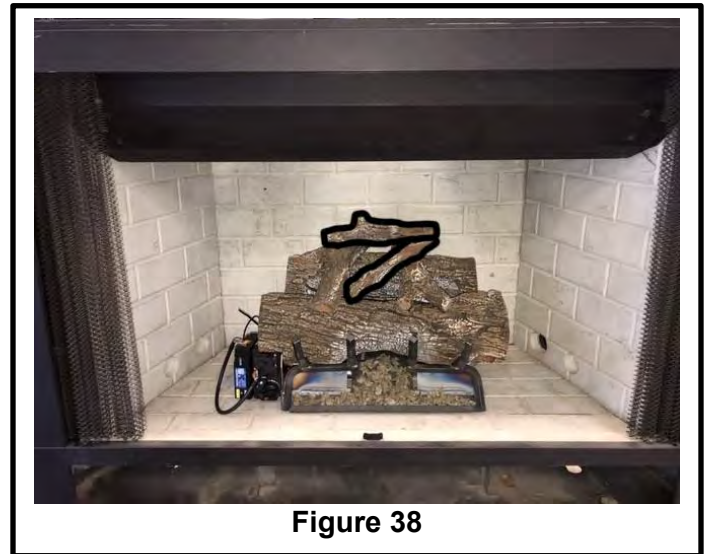

Figure 38

5.1.7.2 24 Log Set Placement – WO/RO

Referring to Figure 39, first place the 24/30-inch back log into place while making sure that the grooves are tightly seated on the burner grate. Then place the 24-inch front log into place. The placement should now be as shown.

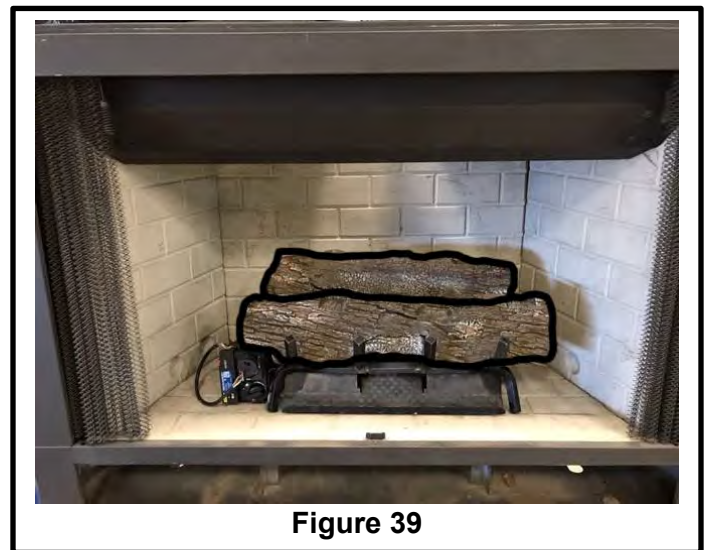

Figure 39

Carefully place the 4 front-to-back inch perpendicular logs on top as shown in Figure 40. Make sure they are stable in this position.

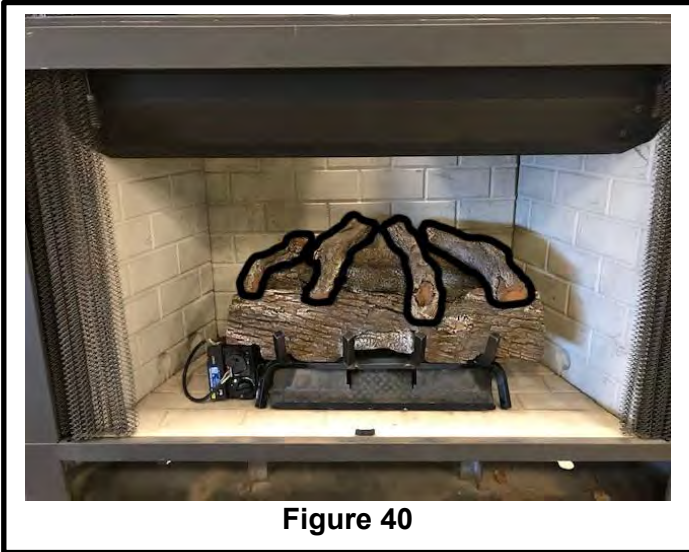

Figure 40

Place the remaining 3 parallel logs on top as shown in Figure 41. There should be a total of 7 logs on top of the burner at this point.

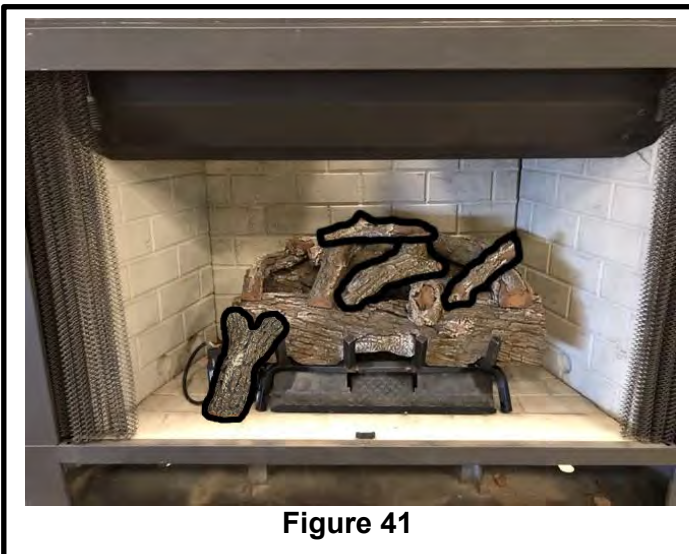

Figure 41

5.1.7.3 30 Log Set Placement – WO/RO

Referring to Figure 42, first place the 24/30-inch back log into place while making sure that the grooves are tightly seated on the burner grate. Then place the 30-inch front log into place. The placement should now be as shown.

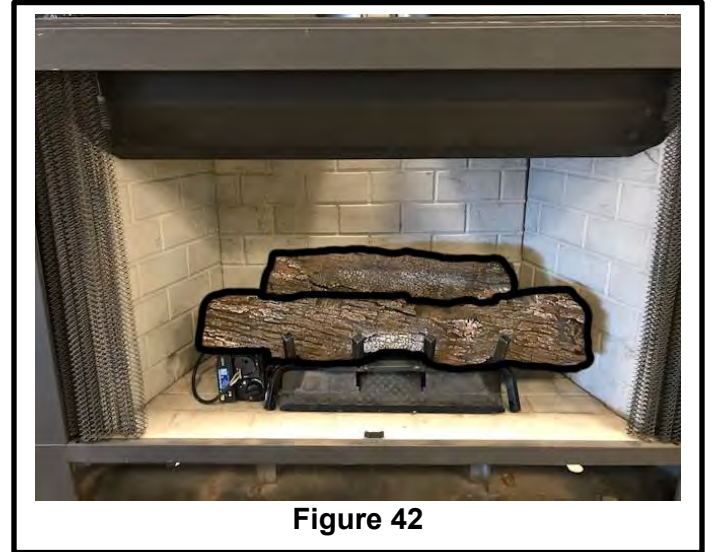

Figure 42

Carefully place the 4 front-to-back inch perpendicular logs on top as shown in Figure 43. Make sure they are stable in this position.

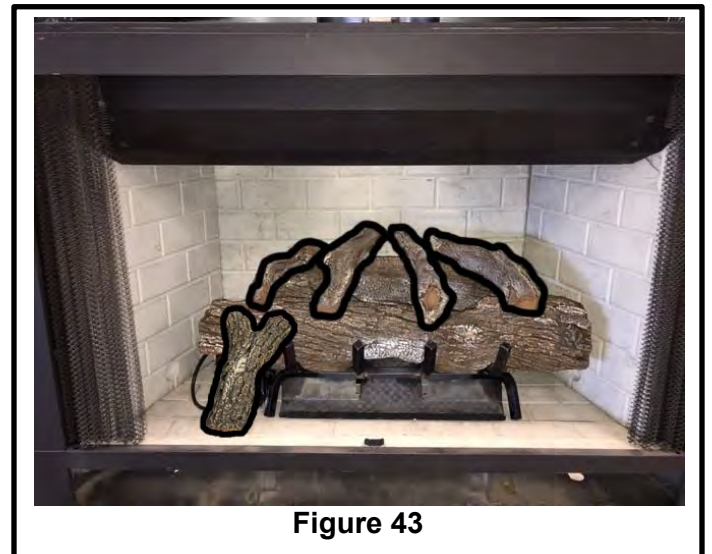

Figure 43

Place the remaining 3 parallel logs on top as shown in Figure 44. There should be a total of 7 logs on top of the burner at this point.

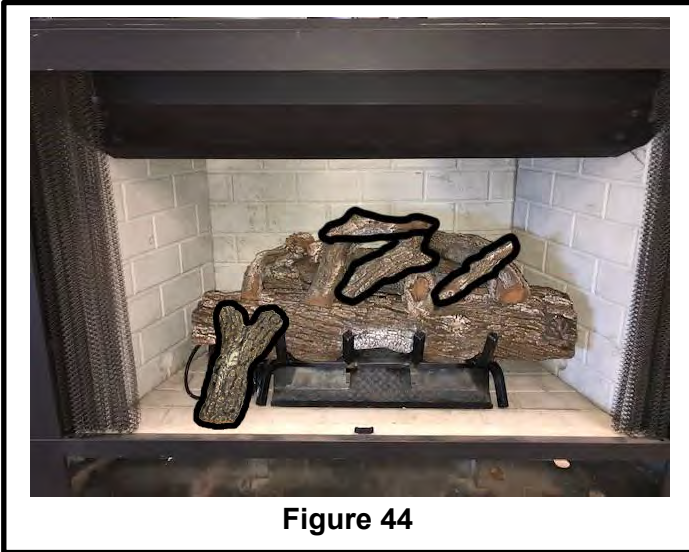

Figure 44

5.1.7.4 Checking the Log Placement

After setting the logs from the appropriate log kit into position as described above, ensure each is properly and firmly seated flat in the grooves or notches.

A vent free gas log set will not function as intended if the logs are not correctly positioned. When placed properly, the flames will not strike any portion of the logs.

Failure to properly place the logs will cause sooting and improper Carbon Monoxide output.

Periodically check the positioning of all logs to ensure proper log placement and stability. If any flame is striking the logs, recheck log placement. Adjust to conform with instructions. There should be no flame impingement on the logs.

Log placement should be re-checked as part of the fireplace maintenance procedure. Logs may not remain in their original position over time.

5.2 Vent Free Logs Parts List

Note: Please refer to the information below for log set part numbers each organized by size, position on the log stack, and appearance.

These may be ordered from the manufacturer using the contact information in the Warranty Section.

NOTE – The log set is packed separately.

WO / RO - 24/30 Log Set					
Item	Description	Weathered Oak Part No.	Qty	Red Oak Part No.	Qty
1.	24" Rear log	VF-Back-21-WO	1	VF-Back-21-RO	1
Or	30" Rear log	VF-Back-21-WO	1	VF-Back-21-RO	1
2.	24" Front log	VF-Front-24-WO	1	VF-Front-24-RO	1
Or	30" Front log	VF-Front-30-WO	1	VF-Front-30-RO	1
3.	Left log	VF-L-9.5-WO	1	VF-L-9.5-RO	1
4.	Left middle log	VF-ML-11.5-WO	1	VF-ML-11.5-RO	1
5.	Middle log	VF-M-10-WO	1	VF-M-10-RO	1
6.	Right middle log	VF-MR-12-WO	1	VF-MR-12-RO	1
7.	Right Accent log	VF-RA-8.5-WO	1	VF-RA-8.58-RO	1
8.	Right log	VF-R-12-WO	1	VF-R-12-RO	1
9.	Middle Lower Log	VF-ML-10-WO	1	VF-ML-10-RO	1
10.	Valve Hiding log	VF-LA-10-WO	1	VF-LA-10-RO	1

24" Log Layout



30" Log Layout

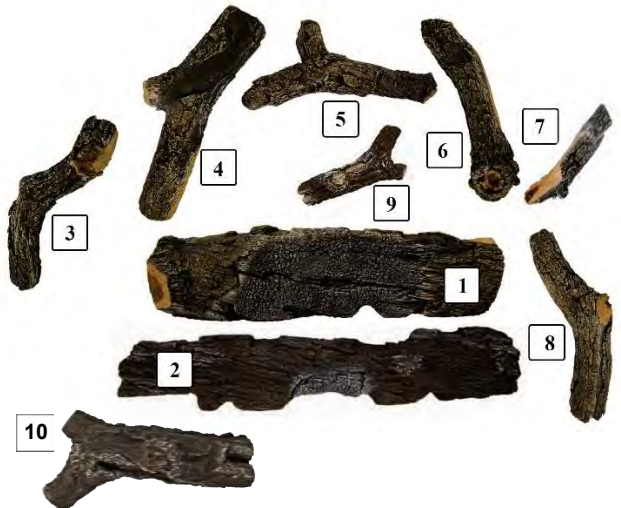

WO / RO - 18 Log Set

Item	Description	Weathered Oak Part No.	Qty	Red Oak Part No.	Qty
1.	17" Rear log	VF-Back-17-WO	1	VF-Back-17-RO	1
2.	19" Front log	VF-Front-19-WO	1	VF-Front-19-RO	1
3.	Left log	VF-L-9.5-WO	1	VF-L-9.5-RO	1
4.	Right log	VF-R-10-WO	1	VF-R-10-RO	1
5.	Middle Top Log	VF-MT-10-WO	1	VF-MT-10-RO	1
6.	Middle log	VF-M-8-WO	1	VF-M-8-RO	1
7.	Valve Hiding Log	VF-LA-10-WO	1	VF-LA-10-RO	1

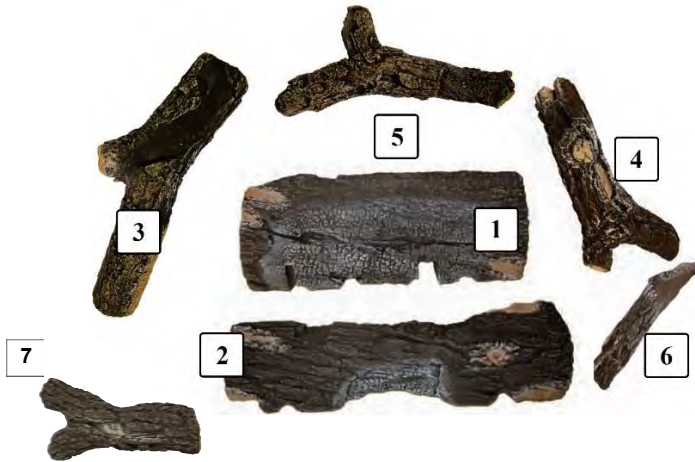

NOTE – The log set is packed separately.

SO - 24/30 Log Set			
Item	Description	Split Oak Part No.	Qty
1.	24" Front Log	VFS-1-24	1
Or	30" Front Log	VFS-1-30	1
2.	24/30 Back Log	VFO-1-21	1
3.	Left Top Log	VFO-C-12	1
4.	Left Middle Top Log	VFO-1-12	1
5.	Right Middle Top Log	VFO-2-12	1
6.	Right Top Log	VFS-1-11	1
7.	Middle Top Log	VFO-2Y-10	1
8.	Middle Center	VFS-Y-10	1
9.	Right Accent	VFS-1-8	1
10.	Valve Hiding Log	VFO-Y-9	1

24" Log Layout



30" Log Layout



SO - 18 Log Set

Item	Description	Split Oak Part No.
1.	18" Front Log	VFS-1-19
2.	18" Back Log	VFO-1-17
3.	Left Top Log	VFO-2-12
4.	Middle Top Log	VFO-2Y-10
5.	Middle Front Log	VFS-1-8
6.	Right Top Log	VFS-2Y-10
7.	Valve Hiding Log	VFO-Y-9



NOTE – The log set is packed separately.

AB - 24/30 Log Set		
Item	Description	Aspen Birch Part No.
1.	22" Rear log	VF-BACK-22-ASP
2.	24" Front log	VF-Front-24-WO
Or	30" Front log	VF-FRONT-30-ASP
3.	Left log	VF-L-12-ASP
4.	Left middle log	VF-ML-12-ASP
5.	Middle Right log	VF-MR-13-ASP
6	Right log	VF-R-13-ASP
7.	Middle log	VF-M-15-ASP
8.	Middle Lower log	VF-ML-8-ASP
9.	Right Accent Log	VF-RA-8.5-ASP
10.	Left Accent log	VF-LA-9-ASP

24" / 30" Log Layout



AB - 18 Log Set

Item	Description	Aspen Birch Part No.	Qty
1.	18" Rear Log	VF-BACK-17-AB	1
2.	18" Front Log	VF-FRONT-19-AB	1
3.	Left Log	VF-L-9.5-AB	1
4.	Right Log	VF-LA-10.AB	1
5.	Middle Log	VF-M-6-AB	1
6.	Middle Top Log	VF-M-12-AB	1
7.	Valve Hiding Log	VF-R-10-AB	1



5.3 Vent Free Burner System Replacement Parts List

Note: Please refer to the list below for system part numbers each type of burner system by the kind of gas valve used. There are illustrations showing the individual burner components on the next several pages.

Parts may be ordered from the manufacturer using the contact information in the Warranty Section.

Burner System Part Numbers		
Valve Type	Assembly P/N	Size and Gas Type
Millivolt	VFVUL18MN	18 Inch Log, Natural
Millivolt	VFVUL18MP	18 Inch Log, Propane
Millivolt	VFVUL24/30MN	24/30 Inch Log, Natural
Millivolt	VFVUL24/30MP	24/30 Inch Log, Propane
Variable Control	VFVUL18VN	18 Inch Log, Natural
Variable Control	VFVUL18VP	18 Inch Log, Propane
Variable Control	VFVUL24/30VN	24/30 Inch Log, Natural
Variable Control	VFVUL24/30VP	24/30 Inch Log, Propane
Variable Electronic	VFVUL18EN	18 Inch Log, Natural
Variable Electronic	VFVUL18EP	18 Inch Log, Propane
Variable Electronic	VFVUL24/30EN	24/30 Inch Log, Natural
Variable Electronic	VFVUL24/30EP	24/30 Inch Log, Propane

BURNER PARTS LIST – VFVUL **M(N/P)

NOTE – Pictures are not to scale – 24/30 Burner model shown

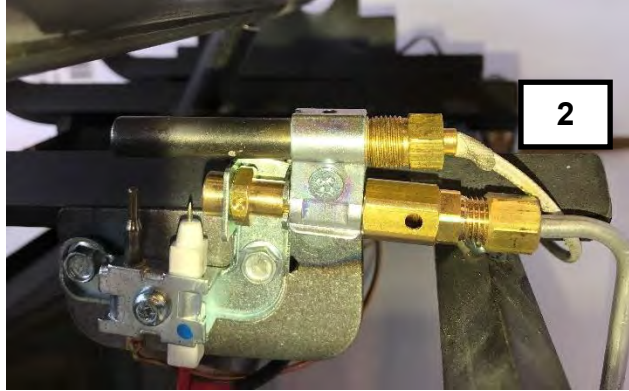
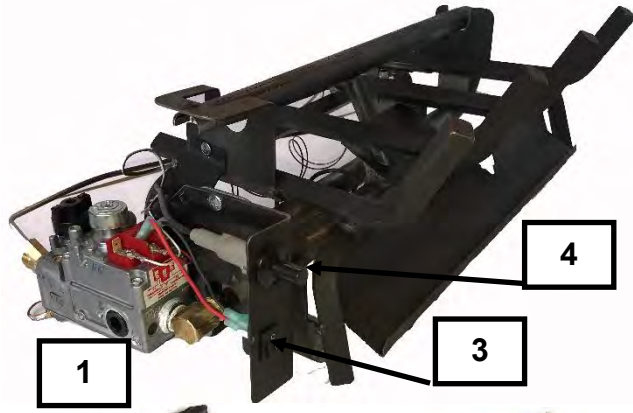

Item	Description	18" Burner	Qty	24" Burner	Qty
1.	Millivolt Control Valve (Natural Gas)	6003KS-NAT	1	6003KS-NAT	1
or	Millivolt Control Valve (Propane)	6003KS-LP	1	6003KS-LP	1
2.	Millivolt ODS Pilot (Natural Gas)	21500/223	1	21500/223	1
or	Millivolt Pilot (Propane)	21500/224	1	21500/224	1
3.	On/Off Rocker Switch	707	1	707	1
4.	Piezo Ignitor	NJ001B1	1	NJ001B1	1
5.	Lava Rock 6lbs.	L6-B	1	L6-B	1
6.	Glowing Embers	GLE-1	1	GLE-1	1
7.	Platinum Embers	PBE-1	1	PBE-1	1
8.	Damper Clamp	00F0545	1	00F0545	1
9.	On/Off Remote Control	GCRK	1	GCRK	1

BURNER PARTS LIST – VFVUL**V(N/P)

NOTE – Pictures are not to scale – 24/30 Burner model shown



1

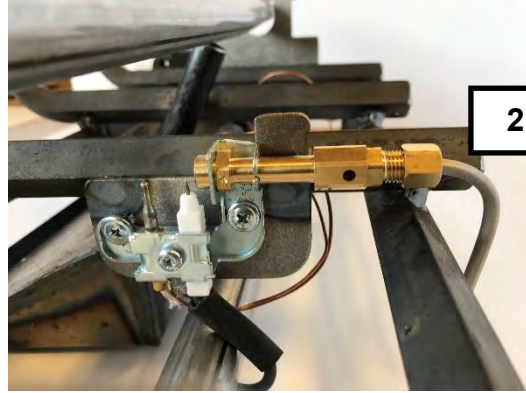

2



3



4



5



6



7

Item	Description	18" Burner	Qty	24" Burner	Qty
1.	Variable Control Valve (Natural Gas) or Variable Control Valve (Propane)	GV34-B1A0NEHM-0002 GV34-B1A0LEHM-0002	1 1	GV34-B1A0NEHM-0002 GV34-B1A0LEHM-0002	1 1
2.	Variable ODS Pilot (Natural Gas) or Variable ODS Pilot	21500/229 21500/233	1 1	21500/229 21500/233	1 1
3.	Lava Rock 6lbs.	L6-B	1	L6-B	1
4.	Glowing Embers	GLE-1	1	GLE-1	1
5.	Platinum Embers	PBE-1	1	PBE-1	1
6.	Damper Clamp	00F0545	1	00F0545	1
7.	On/Off Hi/Lo Remote Control	SR1001TH-1	1	SR1001TH-1	1

BURNER PARTS LIST – VFVUL**E(N/P)

NOTE – Pictures are not to scale – 24/30 Burner model shown

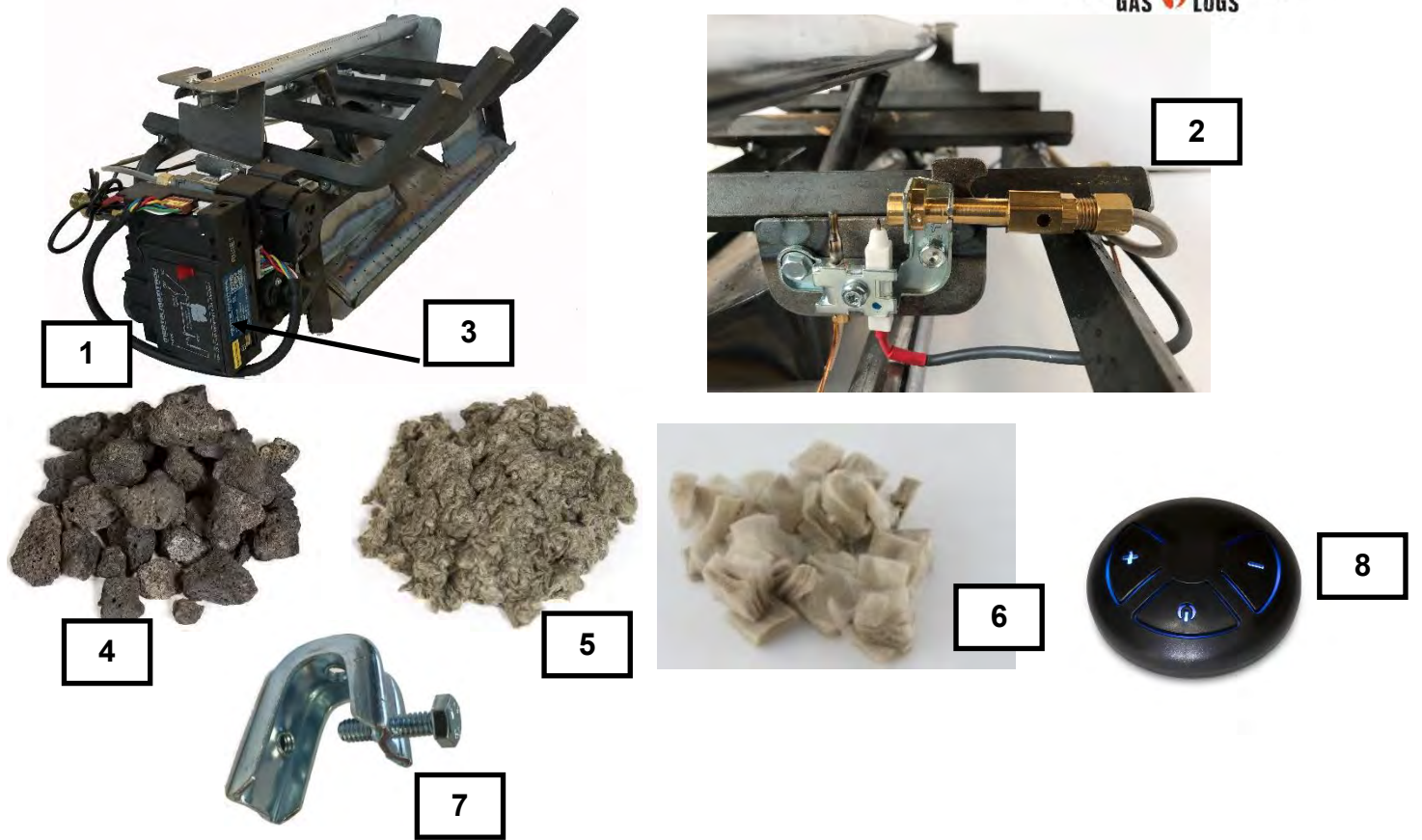

Item	Description	18" Burner	Qty	24" Burner	Qty
1.	Electronic Control Valve (Natural Gas) or Electronic Control Valve (Propane)	GV60M1-B1N1HL-001 GV60M1-B1L1HM-001	1 1	GV60M1-B1N1HL-001 GV60M1-B1L1HM-001	1 1
2.	Electronic ODS Pilot (Natural Gas) or Electronic Pilot (Propane)	21500/297 215100/298	1 1	21500/297 215100/298	1 1
3.	Control Module Electronic	BR6-RAP	1	BR6-RAP	1
4.	Lava Rock 6lbs.	L6-B	1	L6-B	1
5.	Glowing Embers	GLE-1	1	GLE-1	1
6.	Platinum Embers	PBE-1	1	PBE-1	1
7.	Damper Clamp	00F0545	1	00F0545	1
8.	On/Off Remote Control	B6R-H9SPB	1	B6R-H9SPB	1



5.4 Warranty

Refractory Logs: Grand Canyon Gas Logs, logs carry a lifetime warranty against any manufacture defects or breakage as long as the products are installed inside. In the event defect or breakage occurs a replacement will be available to pick-up from the dealer at which the log set was originally purchased. This warranty does not cover breakage caused by excessive handling once installed and fired. Logs installed outdoors carry a (5) year warranty. This warranty is limited to original purchaser only.

Burner: Grand Canyon Gas Logs burners carry a life time warranty against manufacture defects or breakage as long as the appliance is installed inside and by a professional installer. In the event a defect or breakage occurs a replacement will be available for pick-up from the dealer at which the burner was originally purchased. This warranty is limited to original purchaser only. Indoor burners installed outside carry a (1) year warranty

Electrical and Valves: Grand Canyon Gas Logs valves, remotes & receivers carry a (2) year warranty against breakage or defects from date of purchase, by original purchaser, and must be installed be a licensed professional installer. This warranty only covers use with Grand Canyon Gas Logs burners and logs. In the event a defect or breakage occurs a replacement will be available for pick-up from the dealer at which the burner was originally purchased. Batteries are not covered under this warranty. ODS pilot assemblies carry a (1) year warranty.

Quality Control Check

Date: _____

Burner Orifice	NG	LP	Leak Test:	_____	Model#:	_____
Main:	_____	_____	Burn Test:	_____	Serial #:	_____
Ember:	_____	_____	Gas Type:	NG / LP	Air Shutter:	_____

QC Inspector: _____

Contact Information:

Grand Canyon Gas Logs, LLC
 3515 E Atlanta Ave
 Phoenix, AZ 85040
 (602) 344-4217
customerservice@grandcanyongaslogs.com
<http://www.grandcanyongaslogs.com>